

INTRODUCTION

Focus on cleanliness

CleanControlling stands for comprehensive services in the field of cleanliness of surfaces, materials and media in technology, medicine and the environment. One focus here is on the testing and documentation of cleanliness as well as in consultation, training and the special product range for defining, achieving and maintaining technical cleanliness. As a leading international specialist in the field of technical cleanliness for 15 years, CleanControlling has been setting globally standards in laboratory analysis, consulting along the product development process as well as with the specialised product range.

Since its early entry into the world of technical cleanliness in 2006, CleanControlling has been intensively involved in committees and standards for the practical interpretation of directives and has provided important impulses for the further development of these regulations. In addition, the variety of procedures for the extraction and analysis of particulate contaminants was refined and established.

The product range for technical cleanliness

The experience gained from the consulting projects and from analysis has been incorporated into the development of a specialised product range which is finally presented in a comprehensive product catalogue and an eShop. The product range offers a complete selection of accessories related to technical cleanliness. All products have been evaluated under the special technical aspects of technical cleanliness and tested in practice. You benefit from the knowledge and experience of our highly trained cleanliness experts.

Unique in product development is the particle suction extraction system C|PS², a practice-oriented extraction process which is increasingly used in e-mobility processes, especially in battery production.

Chemical-film component cleanliness

The increasing requirements in the area of chemical-film component cleanliness have also led to the development of further methods in chemical analysis to establish further methods. Suitable analysis routines are developed to ensure reliable and meaningful results.

Cleanliness in medical technology and the environment

The preservation of human health in connection with product cleanliness and the absence of pollutants in water, soil and waste is the focus of CleanControlling. For this purpose, CleanControlling Medical GmbH & Co. KG is testing the biological and microbiological-hygienic cleanliness of medical devices since 2014 as an accredited and ZLG and GLP recognised testing laboratory. In the field of environmental analytics water, soil and construction waste intended for recycling are tested for pollutants using accredited test methods.

CleanControlling

Our prices are listed in our online shop at
www.shop.cleancontrolling.com

We would also be happy to provide you with an offer

CONTENTS

1 PARTICLE MONITORING

| | | |
|-----|---|-------|
| 1.1 | Particle traps | 6-8 |
| 1.2 | Particle stamps | 9-13 |
| 1.3 | Particle rocker | 14-15 |
| 1.4 | Sampling extraction for microscope stages | 16-17 |
| 1.5 | Monitoring accessories | 18-19 |
| 1.6 | Analysis method / microscopic evaluation | 20-25 |

2 ASSEMBLY CLEANLINESS

| | | |
|-----|--|-------|
| 2.1 | Marking tape | 28-33 |
| 2.2 | Cleaning and pollution control equipment personnel | 34-41 |
| | - Cleaning of shoe soles | |
| | - Glove cleaning system | |
| | - Assembly gloves | |
| 2.3 | Cleaning equipment for surfaces | 42-56 |
| | - Suction systems | |
| | - Hand roller | |
| 2.4 | Particle visualization | 57-60 |
| 2.5 | Screw cover | 61 |

3 LABORATORY EQUIPMENT

| | | |
|-----|---|-------|
| 3.1 | Laboratory technology | 62-66 |
| 3.2 | Laboratory equipment | 67-71 |
| | - Tweezers, clips, Petri dishes | |
| | - Other laboratory equipment | |
| 3.3 | Laboratory requirements | 72-80 |
| | - Personnel and surfaces | |
| 3.4 | Packaging material | 81 |
| 3.5 | Analysis accessories | 82-89 |
| | - Filter membrane and accessories | |
| | - Normal for extraction, test particles | |
| 3.6 | Microscopy accessories | 90 |
| 3.7 | Particle suction extraction system | 91-93 |

4 MEDICAL

| | | |
|-----|----------------|-------|
| 4.1 | Contact plates | 95-96 |
| 4.2 | Sampling bag | 97 |

1 - PARTICLE MONITORING

The cleanliness quality that can be achieved in a preassembled product is determined by the interaction of numerous factors within the process chain. According to the VDA 19.2 guidelines "Technical cleanliness in assembly - Environment, Logistics, Personnel and Assembly Equipment", these influencing factors include the environment, logistics, personnel and the assembly equipment. This guideline is the basis for the following elaborations on particle monitoring.

The cleanliness quality can also be impaired by particle contamination during assembly. In many cleanliness-critical sectors therefore, the components must be protected during production from the entry of critical impurities from the environment.

By means of particle monitoring, the cleanliness of the components can be determined and improved during assembly, or compliance with the cleanliness requirements can be ensured. Particle monitoring can be implemented using different measuring methods. All of them have the aim of locating critical particle sources.

CleanControlling GmbH supports particle monitoring in your company. Our company has a broad product range to monitor particles found in the production environment in accordance with VDA 19 Part 2 "Technical cleanliness in assembly - Environment, Logistics, Personnel and Assembly Equipment". In addition to our products, we offer you a comprehensive range of laboratory analysis services right up to consulting and training.

The satisfaction of our customers is the highest priority for our company. We are therefore always motivated - beyond our existing product range - to respond to any specific requirements of our customers and to develop individual, customized products. Just get in touch with us.

We would like to introduce you to our range of products and services in the field of particle monitoring in the following.

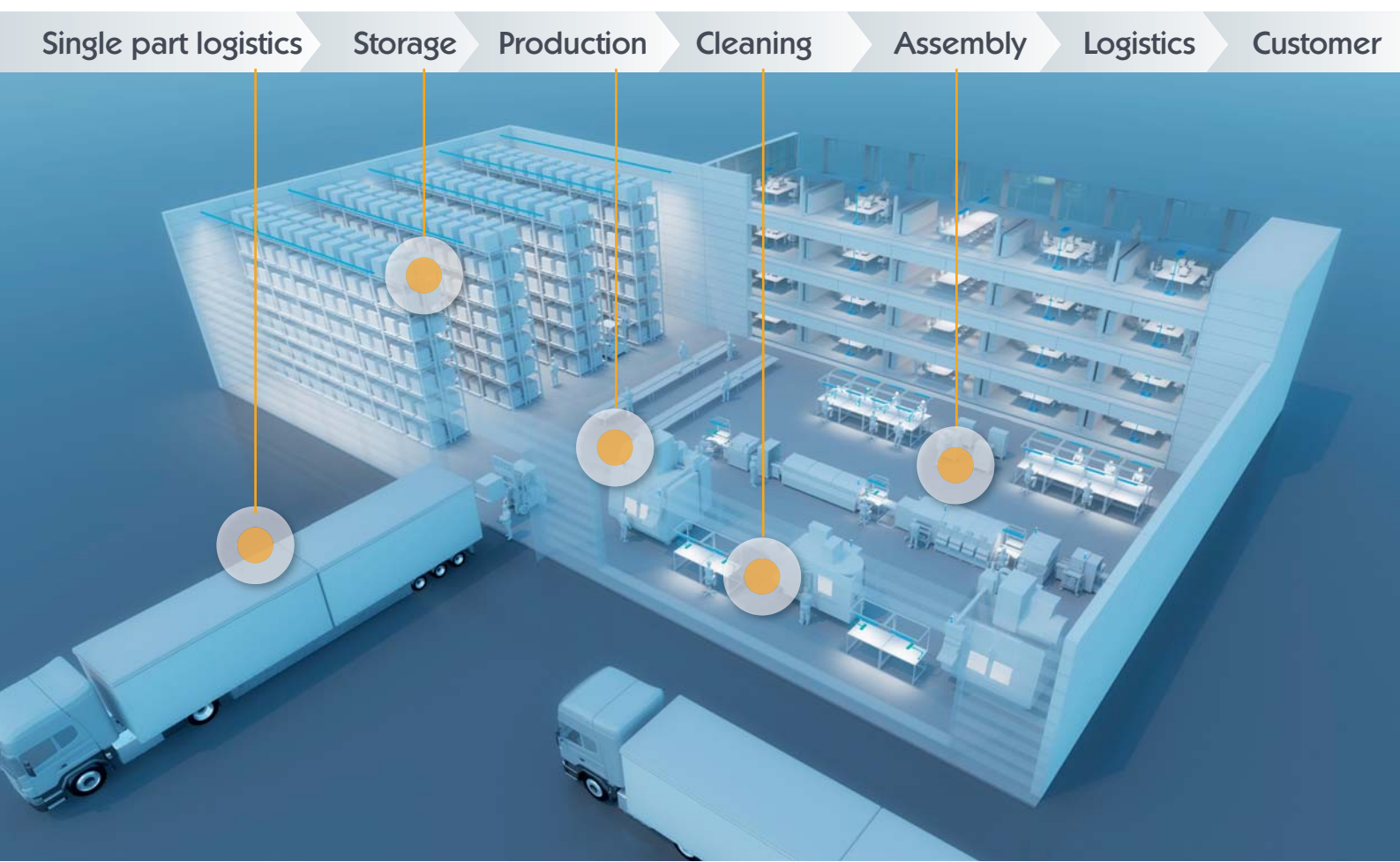

Technical cleanliness in the production chain

The particle trap is a further development of the options described in VDA 19.2 "Technical cleanliness in assembly - Environment, Logistics, Personnel and Assembly Equipment" for monitoring air particles which permits a correlation to be made to the actual contamination of surfaces. It serves for the determination of airborne particle contamination or for the observation of the particle volume at defined, particle-relevant locations in the assembly area, and the supply and process areas.

In addition to this, our company offers accessories matched to the particle traps for fast and optimal placement, as well as the corresponding stereo microscopic analyzes with meaningful test protocol, including picture documentation.



Particle trap

white | ø 47 mm
without microscopic evaluation



| | |
|--------------------------|----------------|
| Art. No. 30001_10 | 10 pcs |
| 30001_100 | 100 pcs |

- Determination of airborne particle contamination
- Observation of the particle volume at defined locations for analysis of cleanliness values (Illig value) according to VDA 19.2

Technical data

- Homogeneous white adhesive pad
- Completely removable mounting options (power strip)

Accessories (optional)

- Mounting angle for particle traps (Art. No. 30005)
- Particle trap stand (Art. No. 30012)
- Microscopic evaluation I white pad (Art. No. 10040 + 10097)
- Blank value certificate I white pad (Art. No. 10041)
- Graphical overall evaluation for particle traps, white (Art. No. 20033)
- Fixing for particle trap
 - or JOMESA microscopes I 1 x (Art. No. 61136)
 - for JOMESA microscopes I 6 x (Art. No. 61417)
 - for LEICA microscopes or dhs-Cleanalyzer I 1 x (Art. No. 61137)

Particle trap

black | \varnothing 41 mm
without microscopic evaluation



| | |
|-------------------|---------|
| Art. No. 30023_10 | 10 pcs |
| 30023_100 | 100 pcs |

- Determination of airborne particle contamination
- Exposure of only bright and white particles and fibers

Technical data

- Homogeneous black adhesive pad
- Completely removable mounting options (power strip)

Accessories (optional)

- Mounting angle for particle traps (Art. No. 30005)
- Particle trap stand (Art. No. 30012)
- Microscopic evaluation | black pad (Art. No. 10073)
- Fixing for particle trap
 - for JOMESA microscopes | 1 x (Art. No. 61136)
 - for JOMESA microscopes | 6 x (Art. No. 61417)
 - for LEICA microscopes or dhs-Cleanalyzer | 1 x (Art. No. 61137)

Note

Automated standard analysis with determination of the sedimentation value is not possible

Mounting angle

for particle trap



Art.No. 30005

- Mounting angle for mounting on walls, steel beams, workbenches or other areas when no horizontal surface is available for the particle trap
- The particle trap can then be fixed to the mounting angle

Technical data

- Completely removable mounting options
- Rounded corners (2xR5)

Accessories (optional)

- Particle trap, white l Ø 47 mm (Art.No. 30001_10 + 30001_100)
- Particle trap, black l Ø 41 mm (Art. No. 30023_10 + 30023_100, 30010_10 + 30010_50)

Particle trap stand

Aluminium



Art.No. 30012

- Particle traps can be easily and safely setup at any location with the help of the particle trap stand
- Particle traps can be placed at different heights

Technical data

- Dimensions (L x W x H): 420 x 420 x 2196.5 mm
- 4 height adjustable booms for placement of the particle traps
- Easy disassembly in 3 parts
- 4 ESD guide rollers with adjuster for placement of the particle trap stand
- Solid aluminum frame profile

Accessories (optional)

- Particle trap, white l Ø 47 mm (Art.No. 30001_10 + 30001_100)
- Particle trap, black l Ø 41 mm (Art.No. 30023_10 + 30023_100)

Note

- Partikelfallenständer auch als Mietvariante erhältlich

The particle stamp is a further development of the options described in VDA 19.2 "Technical cleanliness in assembly - Environment, logistics, personnel and assembly equipment" for monitoring particles which permits a correlation to be made to the actual contamination of surfaces. They are used to make a snapshot of the particle contamination of surfaces.

To meet the individual spatial conditions and production demands of our customers, our company has a series of different particle stamps offering different technical features and benefits.

This enables us to provide the customer with more flexibility, among other things in relation to the contact pressure, the representability of the received particle during a subsequent analysis and the usage - even at hard-to-reach places.

The actual state of surfaces can be received by implementation of a stamp test. On the surface of the particle stamp there is a particle pad to fix the extracted particles from a surface. The particle stamp can be used on hard-to-reach areas.

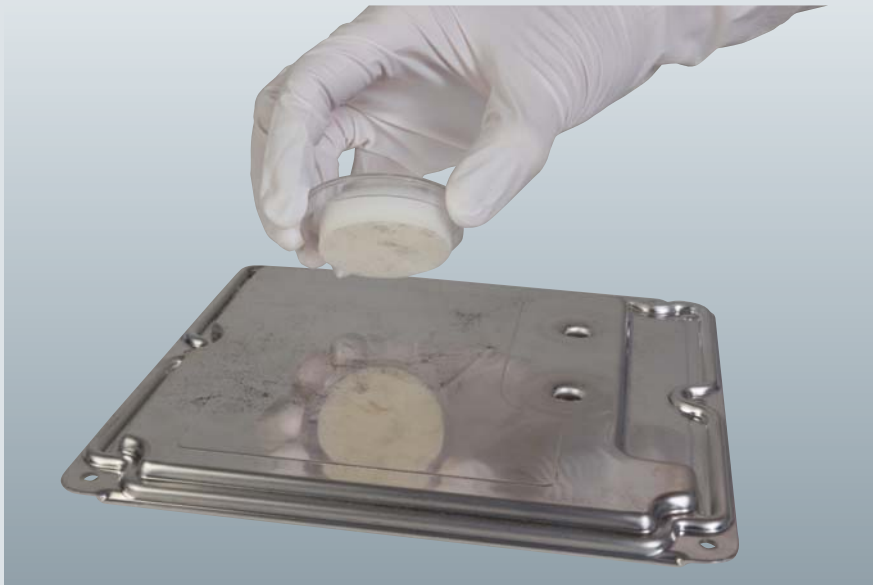

Particle stamps can be developed and produced according to your specifications.

Particle stamp

Spring-mounted | white | \varnothing 41 mm
without microscopic evaluation



Art. No. 30006_10 10 pcs
30006_50 50 pcs

- Particles on a surface can be directly collected and analyzed
- A flexible spring element ensures uniform contact pressure and therefore even particle extraction independent of the tester

Technical data

- White adhesive pad

Accessories (optional)

- Microscopic evaluation | white pad (Art. No. 10040 + 10097)
- Blank value certificate | white pad (Art. No. 10041)
- Stand for particle stamp for JOMESA microscopes | 1 x (Art. No. 61611)
- Stand for particle traps for LEICA microscopes or dhs-Cleanalyzer | 1 x (Art. No. 61137)

Particle stamp

non-spring mounted | white | \varnothing 41 mm
without microscopic evaluation



Art. No. 30007_10 10 pcs
30007_50 50 pcs

- Particles on a surface can be directly collected and analyzed

Technical data

- Homogeneous white adhesive pad

Accessories (optional)

- Microscopic evaluation | white pad (Art. No. 10040 + 10097)
- Blank value certificate | white pad (Art. No. 10041)
- Stand for particle stamp for JOMESA microscopes | 1 x (Art. No. 61611)
- Stand for particle traps for LEICA microscopes or dhs-Cleanalyzer | 1 x (Art. No. 61137)

Particle stamp

non-spring mounted | black | ø 41 mm
without microscopic evaluation



Art. No. 30010_10 10 pcs
30010_50 50 pcs

- Particles on a surface can be directly collected and analyzed
- Exposure of only bright and white particles and fibers

Technical data

- Homogeneous black adhesive pad

Accessories (optional)

- Microscopic evaluation | black pad (Art. No. 10073)
- Stand for particle stamp for JOMESA microscopes | 1 x (Art. No. 61611)
- Stand for particle traps for LEICA microscopes or dhs-Cleanalyzer | 1 x (Art. No. 61137)

Note

- Automated standard evaluation is not possible

Particle stamp SEM

non-spring mounted | white | ø 41 mm
without microscopic evaluation



Art.No. 30035

- Particle stamp for the analysis using the scanning electron microscope (SEM)
- Suitable for the analysis of particles with particle size > 25 µm due to the material basic structures
- Analysis of purely metallic particles possible from a particle size > 5 µm
- Particles on a surface can be directly collected and analyzed

Technical data

- White adhesive pad (several hours vacuum stable)
- Pull-tab for easy removal of the protective film
- Material basic structure of carbon and oxygen and silicon-containing (own) particles < 25 µm
- Conduct pad for fixation in the SEM-sampling table, which is attached on the underside of the SEM stamp
- Dimensions of the box (Ø 45.5 mm) optimally matched into the recess of the SEM-sampling table

Accessories (optional)

- Microscopic evaluation | white pad (Art. No. 10040 + 10097)
- EDX analysis | filter scan (Art. No. 10009 + 10079)
- EDX analysis | per inorganic particle (Art. No. 10002)
- Blank value certificate | white pad (Art. No. 10041)
- Stand for particle stamp for JOMESA microscopes | 1 x (Art. No. 61611)
- Stand for particle traps for LEICA microscopes or dhs-Cleanalyzer | 1 x (Art. No. 61137)

Particle stamp

non-spring mounted | white | \varnothing 23 mm
without microscopic evaluation



Art.No. 30037

- The small diameter offers the possibility of stamping (hard-to-reach) areas and undercuts that were previously unreachable
- Particles on a surface can be directly collected and analyzed

Technical data

- White adhesive pad
- Pull-tab for easy removal of the protective film

Accessories (optional)

- Microscopic evaluation | white pad (Art. No. 10109)
- Stand for particle stamp for JOMESA microscopes | 1 x (Art. No. 61611)
- Stand for particle stamp for JOMESA microscopes | 6 x (Art. No. 6002750)

Particle stamp

spring-mounted | white | \varnothing 13 mm
without microscopic evaluation



Art.No. 30036

- The small diameter offers the possibility of stamping areas and undercuts that were previously unreachable
- A flexible spring element ensures uniform contact pressure and therefore even particle extraction independent of the tester
- Particles on a surface can be directly extracted and analyzed

Technical data

- White adhesive pad
- Pull-tab for easy removal of the protective film

Accessories (optional)

- Microscopic evaluation | white pad (Art. No. 10108)
- Stand for particle stamp for JOMESA microscopes | 1 x (Art. No. 61611)
- Stand for particle stamp for JOMESA microscopes | 6 x (Art. No. 6002750)



The particle rocker allows extraction of the particles from large surfaces such as components, assembly workplaces, driveways, bearing surfaces, containers and packaging.



Particle rocker



Art.No. 61250

- Extraction of large particle contamination on plane surfaces
- Due to the rolling movement, large particles can be extracted with little effort

Technical data

- Particle extraction by affixing of a particle rocker pad, white or black (230 x 50 mm)
- Easy handling for replacing the particle rocker pad

Accessories (optional)

- Particle rocker pad, white | 230 x 50 mm (Art. No. 30028)
- Particle rocker pad, black | 230 x 50 mm (Art. No. 30029)

Particle rockerpad

white
without microscopic evaluation

**Art.No. 30028**

- Particle rocker pad for the particle rocker for determination of particle contamination of large-sized plane surfaces

Technical data

- Homogeneous white particle rocker pad
- Dimensions (L x W): 230 x 50 mm
- Transport/archiving packaging for the particle rocker pad to protect against foreign particles after particle extraction
- Labeling option on the transport/archiving packaging

Accessories (optional)

- Particle rocker (Art. No. 61250)
- Microscopic evaluation I particle rocker pad white (Art. No. 10065)
- Stand for particle rocker pad for JOMESA microscopes (Art. No. 61544)

**Particle rockerpad**

black
without microscopic evaluation

**Art.No. 30029**

- Particle rocker pad for the particle rocker for determination of bright and white particle contamination of large-sized plane surfaces

Technical data

- Homogeneous black particle rocker pad
- Dimensions (L x W): 230 x 50 mm
- Transport/archiving packaging for the particle rocker pad to protect against foreign particles after particle extraction
- Labeling option on the transport/archiving packaging

Accessories (optional)

- Particle rocker (Art. No. 61250)
- Microscopic evaluation I particle rocker pad black (Art. No. 10066)
- Stand for particle rocker pad for JOMESA microscopes (Art. No. 61544)

Note

- Automated standard evaluation is not possible



Stand for particle trap

for JOMESA microscopes | 1 x

**Art.No. 61136**

- Insert plate for fixing of particle traps during microscopic analysis
- Precisely matched to JOMESA microscope systems
- Allows precise evaluation of the particle contamination

Technical data

- Material: aluminum (anodized)
- Dimensions (base plate L x W): 116 x 116 mm

Stand for particle trapfür LEICA-Mikroskopes
und dhs-Cleanalyzer | 1 x**Art.No. 61137**

- Insert plate for fixing of particle traps during microscopic analysis
- Precisely matched to LEICA Microsystems microscopes or dhs-Cleanalyzer
- Allows precise evaluation of the particle contamination

Technical data

- Material: aluminum (anodized)
- Dimensions (base plate L x W): 160 x 116 mm

Stand for particle trap

for JOMESA microscopes | 6 x

**Art.No. 6004374**

- Insert plate for fixing of particle traps during microscopic analysis
- Precisely matched to 6-fold sample table from JOMESA for JOMESA microscope systems
- Allows precise evaluation of the particle contamination

Technical data

- Material: aluminum (anodized) / steel
- Dimensions (L x W): 281 x 150 mm



Stand for particle stamp

for JOMESA microscopes | 1 x



Art.No. 61611

- Insert plate for fixing particle stamps of all sizes during microscopic evaluation
- Precisely matched to JOMESA microscope systems
- Allows precise evaluation of the particle contamination

Technical data

- Material: aluminum (anodized)
- Dimensions (base plate L x W): 116 x 116 mm

Stand for particle stamp

for JOMESA microscopes | 6x



Art. No. 6002750

- Insert plate for fixing particle stamps during microscope evaluation
- Precisely matched to 6-fold sample table from JOMESA microscope system
- Allows precise evaluation of the particle contamination

Technische Daten

- Material: aluminum (anodized)
- Dimensions (base plate L x B): 281 x 150 mm



Stand for particle rocker pad

for JOMESA microscopes



Art.No. 61544

- Insert plate for fixing of extraction pads for particle rocker during microscopic evaluation
- Precisely matched to 6-fold sample table from JOMESA for JOMESA microscope systems
- Allows precise evaluation of the particle contamination

Technical data

- Material: aluminum (anodized)
- Dimensions (base plate L x W): 281 mm x 150 mm
- Engraved with text

Adhesive film
for particles I white



Art.No. 61897

- Adhesive film for extraction of particles from large surfaces and their fixation
- Flexible application due to individual cropping of the film to the desired size

Technical data

- Dimensions (L x W): 360 x 130 mm
- Color: white

Adhesive film
for particles I black

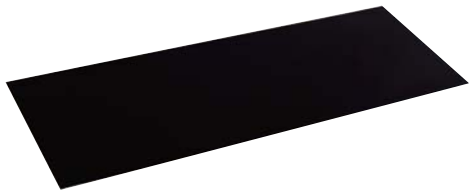

Art.No. 61895

- Adhesive film for extraction of particles from large surfaces and their fixation
- White and bright particles can be visibly seen on the black background
- Flexible application due to individual cropping of the film to the desired size

Technical data

- Dimensions (L x W): 360 x 130 mm
- Color: black

Swab

Universal I cotton

**Art.No. 61503**

- Particle extraction and removal can be done even at places difficult to access
- Designed for application in precision areas
- Cotton is very resistant to chemicals and can therefore be used in many areas

Technical data

- Double, pointed head of cotton
- Head (cotton): approx. Ø 5.0 x 13.0 mm
- Handle (squeezed cotton): approx. Ø 2.5 x 146.0 mm
- 1000 swabs per packaging unit
- Not suitable for the cleanroom

Swab

Cleanroom I polyester

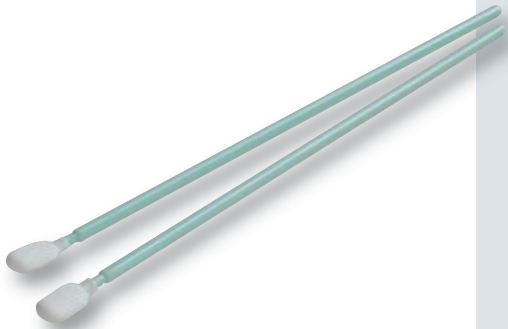
**Art.No. 61504**

- Particle extraction and removal can be done even at places difficult to access
- Suitable for cleanroom class 10 / ISO4
- Lint-free polyester head absorbs particles or residue without scratching the surface

Technical data

- Paddle-like polyester head
- Free of silicone, amides and phthalates
- Head (polyester): 7.5 x 3.0 x 16.0 mm
- Handle (polypropylene): approx. Ø 3.2 x 148.0 mm
- 00 swabs per packaging unit

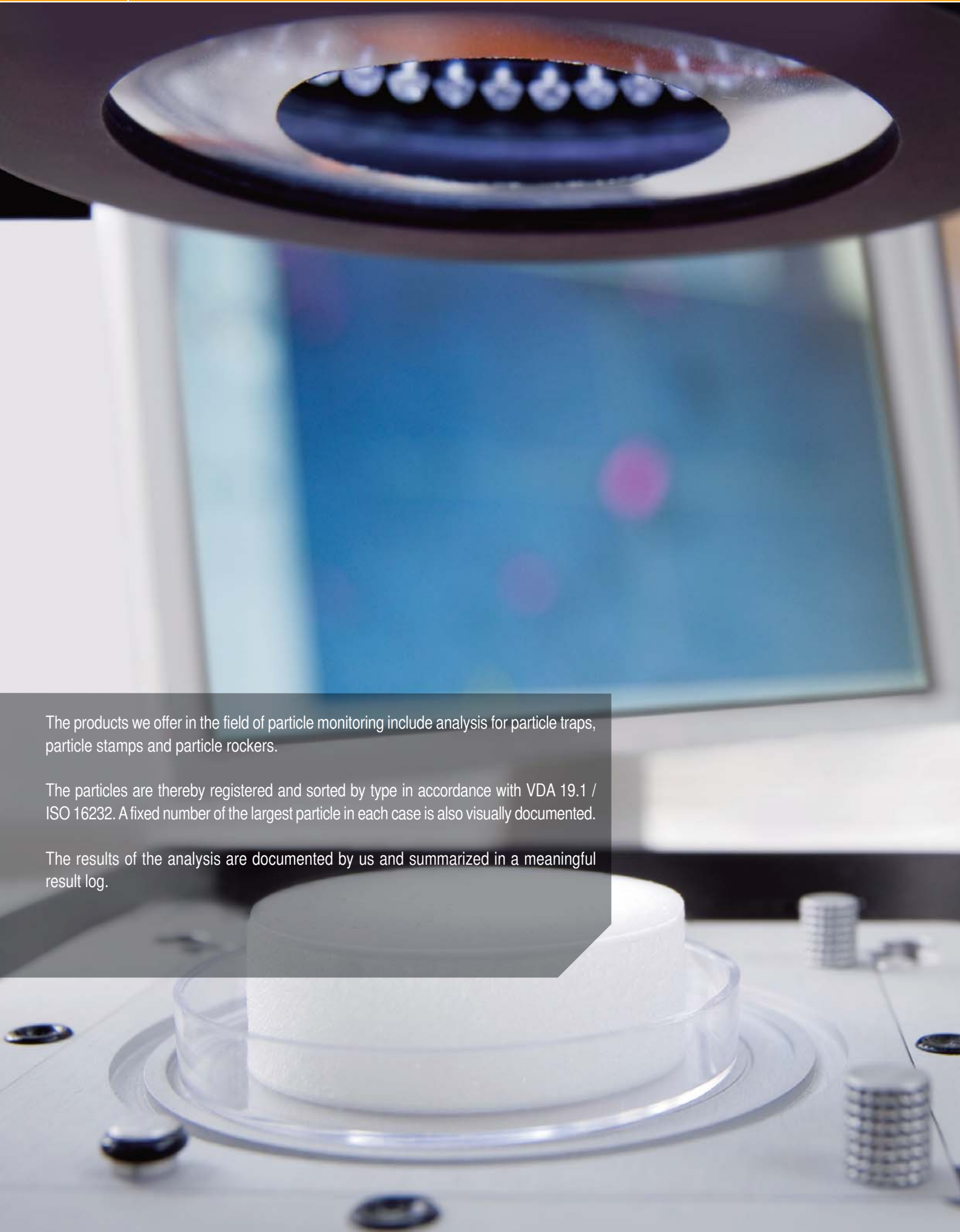

The products we offer in the field of particle monitoring include analysis for particle traps, particle stamps and particle rockers.

The particles are thereby registered and sorted by type in accordance with VDA 19.1 / ISO 16232. A fixed number of the largest particle in each case is also visually documented.

The results of the analysis are documented by us and summarized in a meaningful result log.

To be able to make comparisons with other sites or production areas, the "Illig value" is calculated according to VDA 19.2. This is a cleanliness or sedimentation value.

The standard procedure for the calculation of the Illig value ensures the comparability of different particle traps and their locations and thus makes it possible to measure, assess and where appropriate to "adjust" the cleanliness of the environment, if appropriate improvement measures have been taken and implemented.

In the procedure, the number of particles per particle trap on an area of 1.000 cm² is normalized and the evaluation is calculated for an measuring time of one hour. Furthermore, a weighting factor is applied to the result of the analysis in the individual particle size classes, and the weighted particle figures are summed. The procedure is graphically illustrated in the following figure "Procedure for calculation of the cleanliness value (Illig value)".

The advantage in using the sedimentation value is that the sedimentation results are comparable due to the standardized reference size. The results can be better documented by compressing them to a number per measuring point. However, detailed information is lost.

Calculation of environmental cleanliness or Illig value according to VDA 19.2

| Particle size [μm] | Weighting factor |
|---------------------------------|------------------|
| $5 \leq x < 15$ | 0 |
| $15 \leq x < 25$ | 0 |
| $25 \leq x < 50$ | 0 |
| $50 \leq x < 100$ | 1 |
| $100 \leq x < 150$ | 4 |
| $150 \leq x < 200$ | 9 |
| $200 \leq x < 400$ | 16 |
| $400 \leq x < 600$ | 64 |
| $600 \leq x < 1000$ | 144 |
| $1000 \leq x$ | 400 |

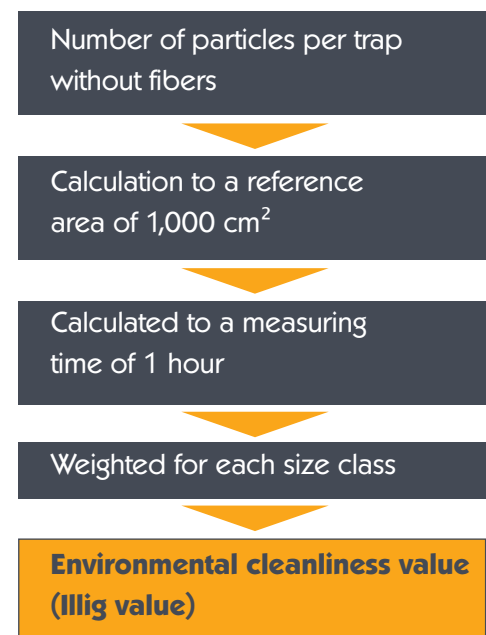

Microscopic evaluation

White pad

| Art.No. | Ø in mm |
|---------|---------|
| 10040 | 41-47 |
| 10109 | 23 |
| 10108 | 10-13 |

from particle size 25 µm

- Photo-optical analysis with identification of metallic luminous and non-luminous particles by means of stereomicroscope
- Preparation of the test specification
- Classification of particles by class of size as per VDA 19.1 / ISO 16232
- Display of the 2 largest metallic luminous particles or non-luminous particles
- For the evaluation of particle traps:
Additional evaluation of the cleanliness value (Illig value)
- Documentation of the findings
- Preparation of a test report
- Archiving of the sampled particle trap/particle stamp in the in-house archive

Application option

- Microscopic evaluation from 15 µm particle size or from 5 µm particle size | Ø 41-47 mm (Art. No. 10040 + 10097)
 - All particle traps & particle stamps, white | Ø 41-47 mm (Art.No. 30001_10 + 30001_100 / 30006_10 + 30006_50 / 30007_10 + 30007_50)
- Microscopic evaluation from 25 µm particle size | Ø 23 mm (Art. No. 10109)
 - Particle stamp, spring-mounted | Ø 23 mm (Art. No. 30037)
- Microscopic evaluation from 25 µm particle size | Ø 10-13 mm (Art. No. 10108)
 - Particle stamp, spring-mounted | Ø 13mm (Art. No. 30036)
 - Particle stamp, non-spring mounted | Ø 10 mm (Art. No. 30037)

Microscopic evaluation

Black pad

Art.No. 10073 Ø 41 mm I from particle size 50 µm

- Photo-optical analysis by means of stereomicroscope with manual post processing
- Preparation of the test specification
- Classification of particles by class of size as per VDA 19.1 / ISO 16232
- Display of the 4 largest particles
- Documentation of the findings
- Preparation of a test report
- Archiving of the sampled particle trap/particle stamp in the in-house archive

Application option

- Particle trap, black I Ø 41 mm
(Art. No. 30023_10 + 30023_100, 30010_10 + 30010_50)
- Particle stamp, non-spring mounted I black I Ø 41 mm (Art. No. 30010_10 + 30010_50)

Microscopic evaluation

White particle rocker pad

Art.No. 10065 210 x 40 mm I from particle size 25 µm

- Photo-optical analysis with identification of metallic luminous and non-luminous particles by means of stereomicroscope
- Preparation of the test specification
- Classification of particles by class of size as per VDA 19.1 / ISO 16232
- Display of the 2 largest metallic luminous particles or non-luminous particles
- Documentation of the findings
- Preparation of a test report
- Archiving of the sampled particle rocker pad in the in-house archive

Application option

- Particle rocker pad, white (Art. No. 30028)

Microscopic evaluation

Black particle rocker pad

Art.No. 10066 210 x 40 mm I from particle size 50 µm

- Photo-optical analysis by means of stereomicroscope with manual post processing
- Preparation of the test specification
- Classification of particles by class of size as per VDA 19.1 / ISO 16232
- Display of each of the 4 largest particles
- Documentation of the findings
- Preparation of a test report
- Archiving of the sampled particle rocker pad in the in-house archive

Application option

- Particle rocker pad, black (Art. No. 30029)

Blank value certificate

White pad

Art.No. 10041 Ø 41-47 mm

- With the blank value certificate, the particle coat from particle traps or particle stamps are analyzed prior to use
- The evaluation of the particle coat is optimized for critical ranges of application.

Application option

- Particle trap, white I Ø 47 mm (Art. No. 30001_10 + 30001_100)
- Particle stamp, spring-mounted I Ø 41 mm (Art. No. 30006_10 + 30006_50)
- Particle stamp, non-spring mounted I Ø 41 mm (Art. No. 30007_10 + 30007_50)

Graphical overall evaluation

for white particle traps I
with short report

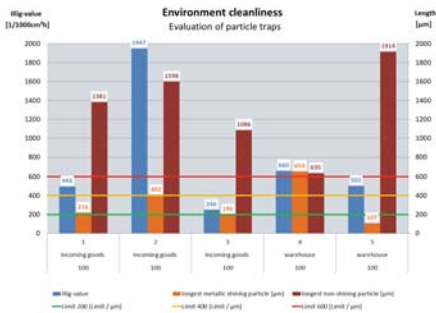

Art.No. 20033

- Graphical display of the particle trap evaluations in the form of a short report
- Classification of the result of the particle traps based on customer or internal requirements

Contents of short report

- Graphical display (chart) of the Illig value, metallic luminous particles and non-luminous particles with requirements/limit values (customer or internal)
- Single chart of the particle traps with particle distribution
- Display of the two largest metallic luminous particles, the two largest non-luminous particles and the two largest fibers
- Brief summary of the results

Application option

- Particle trap, white I Ø 47 mm (Art. No. 30001_10 + 30001_100)
- Particle trap, sterile I white I Ø 41 mm (Art. No. 30038 / 30039)

REM / EDX analysis

Metallic/mineral particles

Art.No. 10009 Filter scan I from particle size 50 µm 10002 for each inorganic particle

- Evaluation of the particles based on their characteristic X-ray spectra from an energy-dispersive X-ray spectroscopy
- Creation of a meaningful test protocol with evaluation of the existing specifications
- Archiving of the sampled analysis membranes in the in-house archive

Application option

- Particle stamp, REM non-spring mounted I white I Ø 41 mm (Art. No. 30035)

Note

- REM/EDX analysis is carried out in cooperation with our partner laboratory
- Services is therefore not in the scope of the accreditation

2 - ASSEMBLY CLEANLINESS



According to VDA 19.2, the cleanliness specification of a component, an assembly or of the assembled system is the starting point for assembly cleanliness during production. The goal is long-term avoidance of the entry of particles during assembly and its adjacent processes, which according to the cleanliness specification must not occur in the component.

However, from a technical and economical perspective, it is rarely possible to completely prevent the emergence and spread of these function-critical particles during complete assembly, its environment and in all logistics processes. Rather, it must be ensured that these cannot reach the cleanliness-critical functional surfaces of the components or assemblies. To meet the large range of cleanliness requirements - especially considering the environmental factor - the VDA 19.2 classifies the spatial environment into "clean areas" with different levels of cleanliness for the design and organization of the assembly area.

In addition to the influencing factor from the environment, the influences of personnel, logistics and packaging, as well as the influences from the processes themselves and of the assembly facilities must be taken into account.

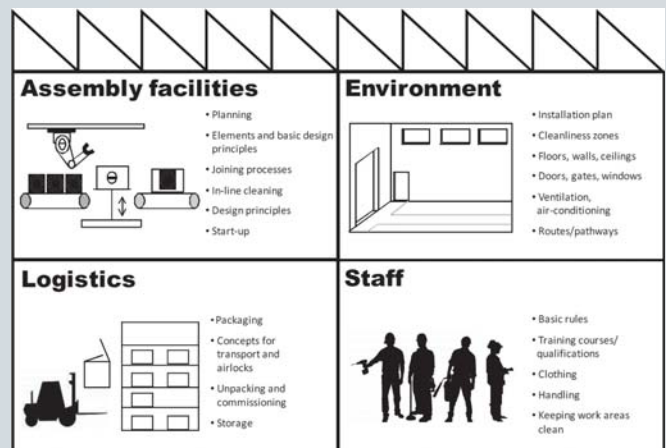

VDA 19.2: Grouping of factors influencing cleanliness into topic blocks that correspond to the chapters in this guide

CleanControlling GmbH supports you in ensuring assembly cleanliness in your company. Based on the above, and on the influencing factors defined in VDA 19.2, we offer a detailed training and consulting program, as well as a comprehensive product range for meaningful support of cleanliness zone and cleanliness room space concepts to reduce these influencing factors. Through our products - which we shall introduce to you in detail in the following - we would like to support you in meeting the high demands made of your products.

For support by means of training and consulting, please also request our separate consulting brochure and get an overview of our service range over the entire production creation process.

The VDA 19.2 "Technical cleanliness in assembly - Environment, Logistics, Personnel and Assembly Equipment" defines the basic function of a clean area as "a sealing-off of contamination influences from non-regulated areas such as mechanical processing or incoming goods, as well from natural environmental influences."

This results in the requirement that particle-generating production areas (e.g. machining) should be separated by design or at least spatially from production lines with cleanliness-sensitive components.

Our company offers you a range of marking tapes, floor markings and supplementary accessories that can be used for optical isolation from other production areas. We support you by this in the realization of cleanliness zones (SaS1) in your company in accordance with VDA 19.2.



Floor marking tape



Art.No. 61252 5 m
61252-1 10 m

- Floor marking tape for the identification of a cleanliness zone (SaS1) according to VDA 19.2
- Self-adhesive, strongly adherent tape for fast laying
- High durability and scratch resistance
- Can be removed almost residue-free
- Easy to clean with soap and water

Technical data

- Length: 5 m or 10 m
- Width: 75 mm
- Thickness: 0.5 mm
- Substrate: PVC
- Adhesive: acrylate
- Inscription: "SAUBERKEITSBEREICH - CLEANLINESS AREA"

Note

- Only suitable for indoor use
- Rotating and turning on the tape with forklifts and similar heavy vehicles should be avoided as this can result in destruction of the material



Barrier / marking tape

with upright

**Art.No. 61258**

- Barrier / marking tape for the identification of a cleanliness zone (SaS1) according to VDA 19.2
- Simple mounting of the powder-coated aluminum tube to the socket plate by quick release in the socket
- High stability and optimum support by heavy cast weight
- Self-winding tape belt within a tape cartridge
- Expansion option for 4 continuous longitudinal slots

Technical data

- Maximum extension length (marking tape): 3000 mm
- Marking tape width: 100 mm
- Profile tube height/diameter: 1000 mm / Ø 83 mm
- Profile tube/socket color: black
- Socket diameter: Ø 355 mm
- Inscription (3x on one side): "SAUBERKEITSBEREICH - CLEANLINESS AREA"

Scope of delivery

- 1 upright consisting of aluminum profile tube and socket plate
- 3 m tape belt within a tape cartridge

Accessories (optional)

- Wall connector 130 mm (Art. No. 61418)
- Tube display DIN A4 (Art. No. 61480)
- Removable frame, angled A4 or A3 | portrait format (Art. No. 61481 / 61482)
- Removable frame, straight A4 or A3 | portrait or landscape format (Art. No. 61483 / 61484 / 61485 / 61486)

Barrier / marking tape for mounting on wall



Art.No. 61389

- Barrier / marking tape for the identification of a cleanliness zone (SaS1) according to VDA 19.2
- Self-winding tape belt within a tape cartridge is integrated in a short powder-coated aluminum profile

Technical data

- Maximum extension length (marking tape): 3 m
- Marking tape width: 100 mm
- Profile tube height/diameter: 173 mm / Ø 83 mm
- Profile tube color: black
- Inscription (3x on one side): "SAUBERKEITSBEREICH - CLEANLINESS AREA"

Scope of delivery

- 3 m tape belt within a tape cartridge
- Mounting back plate (suitable for dowels)

Accessories (optional)

- Wall connector 130 mm (Art. No. 61418)
- Tube display DIN A4 (Art. No. 61480)



Wall connector

130 mm

**Art.No. 61418**

- Wall attachment to fix the tape belt to the wall

Technical data

- Dimensions: 130 mm
- Material: aluminum
- Color: black

Scope of delivery

- Wall connector
- Screws for mounting

Tube display

for DIN A4

**Art.No. 61480**

- Tube display for DIN A4 print media for additional visualization of cleanliness areas
- For mounting on the barrier / marking tape (post and wall)

Technical data

- Material: transparent Plexiglas
- Display height / diameter: 315 mm / Ø 83 mm

Scope of delivery

- Tube display (without print media)
- Adapter for mounting on the barrier / marking tape



Removable frame

angled



Art.No. 61481 Portrait format / DIN A4
61482 Portrait format / DIN A3

- Removable frame for print media
for additional visualization of cleanliness areas
- For mounting on the barrier / marking tape (post)

Technical data

- Material: aluminum
- Color: black

Scope of delivery

- Removable frame
- Adapter for mounting on the barrier/marking tape

Removable frame

straight



| Art. No. | format | DIN-Format |
|----------|------------------|------------|
| 61484 | portrait format | DIN A4 |
| 61486 | portrait format | DIN A3 |
| 61483 | landscape format | DIN A4 |
| 61485 | landscape format | DIN A3 |

- Removable frame for print media
for additional visualization of cleanliness areas
- For mounting on the barrier / marking tape (post)

Technical data

- Material: aluminum
- Color: black

Scope of delivery

- Removable frame
- Adapter for mounting on the barrier/marking tape

The mixed tasks carried out by workers are therefore a key point in the risk analysis and avoidance strategy. Contamination may be displaced via hands, gloves, clothing or footwear and transferred to functional surfaces and the direct environment when certain assembly tasks are carried out.

Our company offers you cleaning mats and various active cleaning systems for shoe soles that can be installed at the entrances and exits of the production area.

With our cleaning units for hands or gloves as well as for large flat surfaces, we provide you with the ability to reduce particle entry or particle spread.

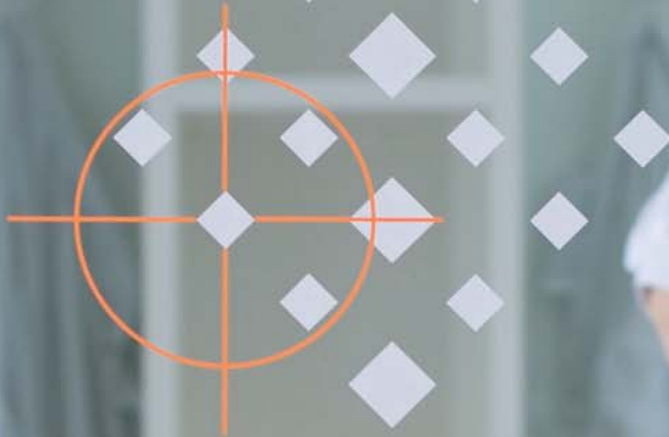

Cleaning mats

for cleaning shoe soles



Art.No. 61254

- Reduction of particle entry by personnel when entering a cleanliness zone (CG 1) or a cleanliness room (CG 2) according to VDA 19.2
- Cleaning of coarse-profiled work shoes with round brush when entering and crossing
- Support in limiting access to authorized personnel by striking colors of the bristles and supplementary marking in the sole regions
- Easy cleaning ability by removal of the vulcanized rubber honeycomb mat from the stainless steel tray

Technical data

- Overall dimensions (L x W x H): 900 mm x 810 mm x 27 mm
- Stainless steel tray: 2 mm (thickness)
- Dimensions of vulcanized rubber honeycomb mat: 800 x 600 mm
- Inscription: "SAUBERKEITSBEREICH - CLEANLINESS AREA"

Accessories (optional)

- Vulcanized rubber honeycomb mat 800 mm x 600 mm (Art. No. 61284)
- Yellow round brush (Art. No. 61508)
- Grey round brush (Art. No. 61509)

Vulcanized rubber honeycomb mat

800 x 600 mm



Art.No. 61284

- Vulcanized rubber honeycomb mat for replacement at the cleaning mat

Technical data

- Dimensions (L x W): 800 mm x 600 mm
- Bristle color: grey/yellow

Round brush

yellow



Art.No. 61508

- Round brush for replacement at the rubber honeycomb mat

Technical data

- Color: yellow
- Minimum order quantity: 10 pieces

Round brush

grey



Art.No. 61509

- Round brush for replacement at the rubber honeycomb mat

Technical data

- Color: grey
- Minimum order quantity: 10 pieces

Solamat 90

Active cleaning system
for sole cleaning

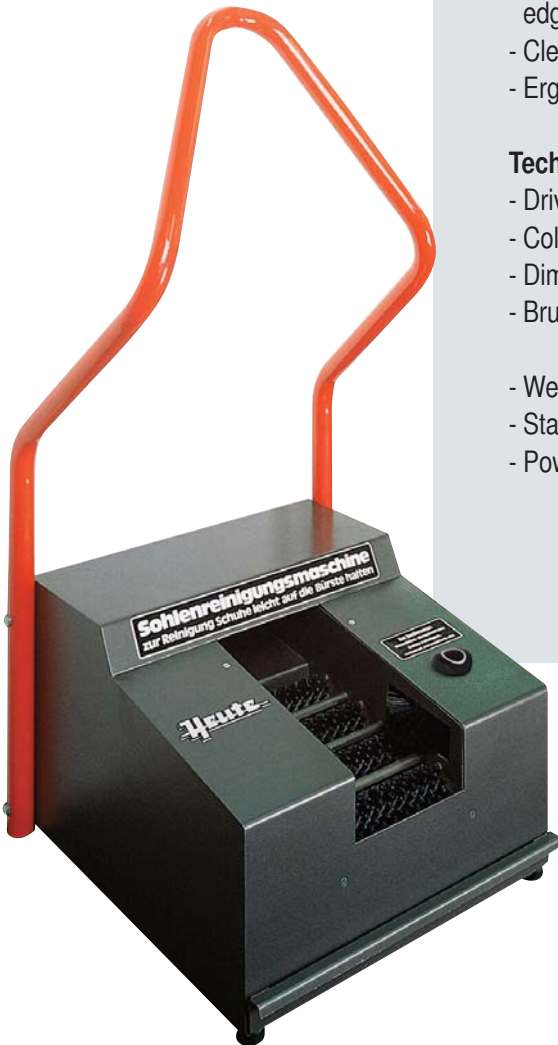
**Art.No. 61683**

- For reduction of particle entry by personnel when entering a cleanliness zone (CG 1) or a cleanliness room (CG 2) as per VDA 19.2
- Cleaning the soles against four countercurrent roller brushes and the sole edges by two lateral rotating nylon round brushes
- Cleaned-off dirt is caught in the drawer below the brush
- Ergonomically curved bracket for a firm grip of the user during cleaning

Technical data

- Drive: round belt drive and powerful motor
- Color: graphit with red holder
- Dimensions (L x W x H): 460 x 560 x 1140 mm
- Brushes: 4 nylon roller brushes,
2 nylon round brushes
- Weight: 50 kg
- Starter: foot sensor with timer
- Power connector: 230 Volt

Glove cleaning system

**Art.No. 61205**

- For the regular cleaning of hands and gloves in production
- Removal of micro-particles to prevent negative influence of the production process
- Can be used free-standing or mounted at work stations or walls
- Adhesive roller can be easily replaced
- Leaves no residue on the material to be processed

Technical data

Dimensions (L x W x H): 245 mm x 100 mm x 125 mm

Accessories (optional)

- Replacement - adhesive roll (No. 61206)

Replacement - adhesive roll

**Art.No. 61206**

- Replacement adhesive roll for the hand cleaning system

Technical data

- Adhesive roll
- Removed in layers

Assembly gloves

white



| | | | |
|---------|-------|------|----|
| Art.No. | 61358 | Size | 6 |
| | 61359 | Size | 7 |
| | 61251 | Size | 8 |
| | 61360 | Size | 9 |
| | 61361 | Size | 10 |

- To perform precision work in the mechanical engineering industry and the automotive industry
- Contamination due to the glove color is clearly visible
- Excellent abrasion resistance for long durability
- Good perspiration absorption
- Excellent tactile sensitivity due to use of fine material
- High wearing comfort with seamless knit lining

Technical data

- Material: polyurethane foam
- 10 pairs per packaging unit

Accessories (optional)

- Hand and glove cleaner (Art. No. 61205)

The aim of integrated cleaning during assembly is to remove particles immediately during or after their emergence to prevent any possible contamination of the components or the production environment.

Particles that are often only loosely bound on the surface can arise due to scoring when joining, handling or separating components. If these impurities are critical for further production process, measures should be taken for integrated cleaning during assembly. Various procedures are used for this, and these have to be selected for the specific application at hand.

A commonly used technique for manual cleaning of the workpiece carrier is the use of blow guns. However, in this case particles are distributed randomly into the direct process environment. Blow guns should therefore be generally replaced by suction guns in a cleanliness-sensitive production environment.. The suction gun is based on the Venturi principle. In this, a vacuum is generated in the suction tube by directing compressed air through a ring nozzle. Particle and chips are fed to the exhaust hose by the incoming air from the outside. The extracted particles are collected in a container. This allows particles to be defined removed from the process environment.

In combined Vac-blast systems, a compressed air jet can be activated in addition to the suction air flow. The compressed air jet is used, for example, to release stubborn dirt on surfaces or blows trapped particles out blind holes.

CleanControlling GmbH supports you in the process of integrated cleaning during assembly in your company. We offer you a wide range of suction systems or combined Vac-blast systems. In addition, we provide you with an extensive selection of brushes, nozzles and filters for the flexible use of our products in many areas.

ELEPHANT Trolley EL 110 M

Vac-blast system with
integrated ionization

Art.No. 61804

- Cleaning equipment for manual, electrostatic-supported removal of dry dusts from surfaces
- Removal of electrostatic surface charges and release of particles adhering due to static charge from level or shaped surfaces by ionization, compressed air and extraction
- Complete mobile system with integrated cleaning head that can be moved manually over the component surface
- Energy-saving and low noise
- Integrated filter and brush are easily changeable

Technical data

- Dimensions (L x W x H): 530 x 320 x 600 mm
- Diameter (cleaning head): Ø 60 mm
- Weight: 18 kg
- Compressed air supply: max. 2 bar (Class 3, ISO 8573)
- Compressed air consumption: 60 l/min (at 1 bar)
- Nominal power: 190 m³/h (at 1900 Pa)
- Sound pressure level: 49 dB (without compressed air)
- Ambient temperature: 5 - 55 °C
- Supply voltage: 230 V
- Extraction hose/compressed air hose/high-voltage cable/sensor cable/power cable: 2 m
- With operating mode display

Scope of delivery

- ELEPHANT Trolley cleaning equipment
- Operating instructions

Accessories (optional)

- Brush for ELEPHANT Trolley EL 110 M (Art. No. 61805)

Note

Brush and compressed air supply line are not included in the scope of delivery



Brush

for ELEPHANT Trolley EL 110 M



Art.No. 61805

- Cleaning brush for ELEPHANT Trolley EL 110 M

Technical data

- Cleaning brush Ø 60 mm with smooth bristles
- Black bristles made of polypropylene (PP)
- Bristle diameter: 0.2 mm
- Filament length: 30 mm

Suction gun

SP 14 | MB 1,5 | Aerosol filter



Art.No. 61111

- Suction gun SP 14 for targeted suction of non-toxic particles and short chips
- Type SP 14 MB 1.5 for moist particles - e.g. short metal chips during thread cutting
- Infinitely-variable adjustment of the suction power possible using a hand lever
- Extraction of particles up to max. 9.5 mm (round suction tube) or 3 mm (flattened suction tube or flat nozzle/brush)

Technical data

- Compressed air connection: nominal width 10 mm, 6 bar, 420 NI/min
- Compressed air quality: class 5 (DIN ISO 8573-1)
- Suction power: vacuum -350 mbar (35 %)
- Suction volume flow: 500 NI/min
- Sound pressure: 80 dB
- Weight: 1.8 kg
- Suction tube: nominal width 14 mm

Scope of delivery

- 1.5 liters - Container with removable aerosol filter
- Holder with mounting bracket for wall mounting
- Compressed air hose, nominal width 10 mm (3 m long)
- Antistatic exhaust hose, nominal width 20 mm (length 3m)
- 4-piece brush/nozzle set:
 - Round brush Ø 40 mm (Art. No. 61144)
 - Flat nozzle without bristles (Art. No. 61145)
 - Flat brush with hard bristles (Art. No. 61146)
 - Flat brush with soft bristles (Art. No. 61147)

Accessories (optional)

- Fine filter for separation of aerosols (No. 61114)
- All round brushes and flat nozzles are suitable for suction mode (see Suction system accessories)

Suction gun

SP 14 | WS | Felt filter

Art.No. 61142

- Suction gun SP 14 for targeted suction of non-toxic particles and short chips
- Type SP 14 WS for dry particles - e.g. short metal chips
- Infinitely-variable adjustment of the suction power possible using a hand lever
- Extraction of particles up to max. 9.5 mm (round suction tube) or 3 mm (flattened suction tube or flat nozzle/brush)

Technical data

- Compressed air connection: nominal width 10 mm, 6 bar, 420 NI/min
- Compressed air quality: class 5 (DIN ISO 8573-1)
- Suction power: vacuum -350 mbar (35 %)
- Suction volume flow: 500 NI/min
- Sound pressure: 80 dB
- Weight: 0.7 kg
- Suction tube: nominal width 14 mm

Scope of delivery

- Felt Filter bag with screw lid
- Antistatic exhaust hose, nominal width 20 mm (length 0.3m)
- 4-piece brush/nozzle set:
 - Round brush Ø 40 mm (Art. No. 61144)
 - Flat nozzle without bristles (Art. No. 61145)
 - Flat brush with hard bristles (Art. No. 61146)
 - Flat brush with soft bristles (Art. No. 61147)

Accessories (optional)

- Felt filter bag suction gun (Art. No. 68233)
- All round brushes and flat nozzles are suitable for suction mode (see Suction system accessories)



Vac-blast system

BS 14 | MB 1,5 | Aerosol filter

Art.No. 61273

- Vac-blast cleaner BS 14 for targeted suction of non-toxic particles and short chips
- Type BS 14 MB 1.5 for stubborn or trapped moist particles (e.g. short metal chips in blind holes)
- Button for additional activation of a compressed air jet to the suction air flow
- Extraction of particles up to max. 7 mm or 3 mm when using the flat nozzle (only in suction mode)

Technical data

- Compressed air connection: 1/4", 6 bar, 420 NI/min (suction mode) and 460 NI/min (blast mode)
- Compressed air quality: class 5 (DIN ISO 8573-1)
- Suction power: vacuum -300 mbar (30 %)
- Suction volume flow: 380 NI/min
- Sound pressure: 75 dB (suction mode) and 77 dB (blast mode)
- Weight: 1.2 kg
- Suction tube: Ø 14 mm

Scope of delivery

- 1.5 liters - container with removable aerosol filter
- Antistatic exhaust hose, nominal width 20 mm (length 1.5 m)
- Vac-blast unit with suction hose, nominal width 15 mm and compressed air hose, nominal width 3 mm (each 1.5 m long)
- Holder with mounting bracket for wall mounting

Accessories (optional)

- Fine filter for separation of aerosols (No. 61114)
- All round brushes are suitable for suction and blast mode (see Suction system accessories)
- All flat nozzles are only suitable for suction mode (see Suction system accessories)



Vac-blast system

BS 14 I MB 1.5 I Felt filter

Art.No. 61290

- Vac-blast cleaner SP 14 for targeted suction of non-toxic particles and short chips
- Type BS 14 MB 1.5 for stubborn or trapped dry particles (e.g. short metal chips)
- Button for additional activation of a compressed air jet to the suction air flow
- Extraction of particles up to max. 7 mm or 3 mm when using the flat nozzle (only in suction mode)

Technical data

- Compressed air connection: 1/4", 6 bar, 420 NI/min (suction mode) and 460 NI/min (blast mode)
- Compressed air quality: class 5 (DIN ISO 8573-1)
- Suction power: vacuum -300 mbar (30 %)
- Suction volume flow: 380 NI/min
- Sound pressure: 75 dB (suction mode) and 77 dB (blast mode)
- Weight: 1.05 kg
- Suction tube: Ø 14 mm

Scope of delivery

- 1.5 liters - container with removable felt filter bag
- Antistatic exhaust hose, nominal width 20 mm (length 1.5 m)
- Vac-blast unit with suction hose, nominal width 15 mm and compressed air hose, nominal width 3 mm (each 1.5 m long)
- Holder with mounting bracket for wall mounting

Accessories (optional)

- Felt filter bag vac-blast cleaner (Art. No. 61660)
- All round brushes are suitable for suction and blast mode (see Suction system accessories)
- All flat nozzles are only suitable for suction mode (see Suction system accessories)



Vac-blast system

MS 14 | MB 2 | Aerosol filter

Art.No. 61265

- Vac-blast cleaner MS 14 for targeted suction of non-toxic particles and short chips
- Type BS 14 MB 2 for stubborn or trapped moist particles - e.g. short metal chips in blind holes
- Button for additional activation of a compressed air jet to the suction air flow
- Extraction of particles up to max. 7 mm or 3 mm when using the flat nozzle (only in suction mode)

Technical data

- Compressed air connection: 1/4", 6 bar, 310 NI/min (suction mode) and 350 NI/min (blast mode)
- Compressed air quality: class 5 (DIN ISO 8573-1)
- Suction power: vacuum -290 mbar (29 %)
- Suction volume flow: 230 NI/min
- Sound pressure: 62 dB (suction mode) and 72 dB (blast mode)
- Weight: 5.7 kg
- Suction tube: Ø 14 mm

Scope of delivery

- 2 liters - Container (transparent) with mounted filter housing for aerosol filter
- Compressed air hose, nominal width 10 mm (3 m long)
- Vac-blast unit with suction hose, nominal width 15 mm and compressed air hose, nominal width 3 mm (each 1.6 m long)

Accessories (optional)

- Fine filter for separation of aerosols (No. 61114)
- All round brushes are suitable for suction and blast mode (see Suction system accessories)
- All flat nozzles are only suitable for suction mode (see Suction system accessories)



Aerosol suction system

MS 15 | MB 2 | 3-fold aerosol filter

**Art.No. 61266**

- Vac-blast cleaner MS 15 for targeted suction of moist particles
- Type MS 15 MB 2 for moist particles
e.g. short metal chips during thread cutting
- Activation of the compressed air supply line by a ball valve
- Extraction of particles up to max. 7 mm
or 3 mm when using the flat nozzle (only in suction mode)
- A greater volume of liquid can be extracted by use of three stacked fine filters

Technical data

- Compressed air connection: 1/4", 6 bar, 300 NI/min
- Compressed air quality: class 5 (DIN ISO 8573-1)
- Suction power: vacuum -340 mbar (34 %)
- Suction volume flow: 250 NI/min
- Sound pressure: 68 dB
- Weight: 14 kg
- Suction tube: Ø 14 mm

Scope of delivery

- 2 liters - container (transparent) with mounted filter housing for three aerosol filters
- Suction unit with suction hose, nominal width 15 mm and (length 1.6 m)

Accessories (optional)

- Fine filter for separation of aerosols (No. 61114)
- All round brushes and flat nozzles are suitable for suction mode (see Suction system accessories)

Round brush

ø 22 mm | soft

**Art.No. 61115****Technical data**

- Round brush Ø 22 mm with smooth bristles
- Nominal width: 14 mm
- White polyamide bristles
- Bristle diameter: 0.1 mm
- Filament length: 8 mm

Round brush

ø 22 mm | hard

**Art.No. 61116****Technical data**

- Round brush Ø 22 mm with hard bristles
- Nominal width: 14 mm
- Black polyamide bristles
- Bristle diameter: 0.2 mm
- Filament length: 8 mm

Double round brush

ø 40 mm | soft

**Art.No. 61117****Technical data**

- Round brush Ø 40 mm with smooth bristles
- Nominal width 14 mm
- Black polyamide bristles
- Bristle diameter 0.1 mm
- Filament length
 - Outer bristle ring: 20 mm
 - Inner bristle ring: 10 mm

Round brush

ø 40 mm | soft

**Art.No. 61144****Technical data**

- Round brush Ø 40 mm with smooth bristles
- Nominal width 14 mm
- Black polyamide bristles
- Bristle diameter 0.1 mm
- Filament length 10 mm

Round brush

ø 24 mm | soft | splayed

**Art.No. 61148****Technical data**

- Round brush Ø 24 mm with smooth bristles
- Nominal width 14 mm
- Bristle ring splayed to the outside
- White polyamide bristles
- Bristle diameter 0.1 mm
- Filament length 8 mm

Round brush

ø 24 mm | hart | splayed

**Art.No. 61149****Technical data**

- Round brush Ø 24 mm with hard bristles
- Nominal width 14 mm
- Bristle ring splayed to the outside
- Black polyamide bristles
- Bristle diameter 0.2 mm
- Filament length 8 mm

Flat nozzle
without bristles



Art.No. 61145

Technical data

- Flat nozzle without bristles
- Nominal width 14 mm

Note

- Flat nozzle is only suitable for suction mode

Flat brush
hard bristles



Art.No. 61146

Technical data

- Flat brush with one row of hard bristles
- Nominal width 14 mm
- Black polyamide bristles
- Bristle diameter 0.2 mm
- Filament length 10 mm

Note

- Flat brush is only suitable for suction mode

Flat brush
soft bristles



Art.No. 61147

Technical data

- Flat brush with two rows of soft bristles
- Nominal width 14 mm
- Black polyamide bristles
- Bristle diameter 0.1 mm
- Filament length 10 mm

Note

- Flat brush is only suitable for suction mode

Replacement nozzle

flat

**Art.No. 61153****Technical data**

- Replacement nozzle with flat suction tube
- made of nickel-plated brass
- Nominal width 14 mm
- Suction tube length 120 mm

Replacement nozzle

round

**Art.No. 61152****Technical data**

- Replacement nozzle with round suction tube
- Material: nickel-plated brass
- Nominal width 14 mm
- Suction tube length 120 mm

Holder

for 1.5 liters container

**Art.No. 61113**

- Holder with mounting bracket for wall mounting

Technical data

- Dimension (W x H) 105 x 115 mm



Fine filter

for separation of aerosols

**Art.No. 61114**

- Suitable for moist particles, e.g. short metal chips during thread cutting

Technical data

- Filter height 60 mm
- Filter diameter Ø 85 mm

Felt filter bag

Suction gun

**Art.No. 61233**

- Suitable for dry, non-toxic particles and short metal chips

Technical data

- Felt filter bag with screw lid
- Filter bag length 170 mm
- Including 0.3 m anti-static exhaust hose with nominal width 20 mm

Felt filter bag

Vac-blast system

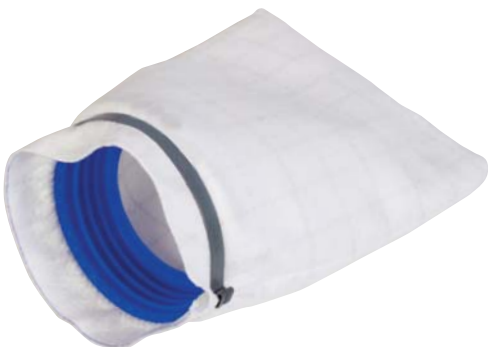
**Art.No. 61660**

- Suitable for dry, non-toxic particles and short metal chips

Technical data

- Felt filter bag for screwing onto 1.5 liters container
- Filter bag length 170 mm

EASY hand roller

150 mm | 300 mm



Art.No. 61477 150 mm cleaning width
61408 300 mm cleaning width

- Adhesive roller for extraction of particles
- For the regular cleaning of plane surfaces
- By rolling on an adhesive pad, the adherent particles are removed by the hand roller and fixed permanently onto the adhesive pad

Technical data

Cleaning width of 150 mm or 300 mm

Accessories (optional)

Adhesive pad (Art. No. 61421)

PROFESSIONAL hand roller

150 mm | 300 mm



Art.No. 61478 150 mm cleaning width
61409 300 mm cleaning width

- Adhesive roller for extraction of particles
- For the regular cleaning of plane surfaces
- By rolling on an adhesive pad, the adherent particles are removed by the hand roller and fixed permanently onto the adhesive pad

Technical data

- Stable, robust design
- Cleaning width of 150 mm or 300 mm

Accessories (optional)

Adhesive pads (Art. No. 61421)

Adhesive pads

250 sheets | 330 x 235 mm

**Art.No. 61421**

- The particles extracted by the hand roller can be permanently fixed by rolling them onto the adhesive pads
- Cleaning the hand roller for re-use
- On saturation of the adhesive pad with particles, this side is separated and the new side is immediately activated

Technical data

- Dimensions (L x W): 330 x 235 mm
- 250 sheets per adhesive pad
- 5 adhesive pads per packaging unit

Particles on the surface can better be made visible through the use of a grazing light. This is due to the contrast created by the illuminated particles and the resulting shade. The degree of cleanliness is then assessed using a reference table, if required.

Different types of particles can be made visible depending on the light source used in the particle visualization. For instance, UV light makes fluorescent particles visible to the naked eye. You can also detect non-fluorescent particles with strong white light.

The particle visualization process combines the advantage of easy handling with the ability to quickly assess the state of cleanliness in your daily work routine. However, it is important to note that this is only a rough estimate of the state - without measuring and comparison values. References are necessary for the actual assessment of cleanliness.

Our product range in the field of particle visualization offers you a variety of tools to control possible contamination in everyday working life. This allows quality standards to be optimized even before more complex, indirect measuring methods are used.

Particle visualization lamp

PVL 2 | UV light



Art.No. 61210

- Visualization of fluorescent particles by UV light on all surfaces, e.g. plastic, stainless steel and aluminum as well as wipes or cleanroom clothing
- Allows the regular visual control of contamination in the cleanroom
- Cleaning operations can be directly optimized - without the use of a measuring device

Technical data

- Dimensions (L): 190 mm, Ø 52 mm
- Wavelength: 365 nm (UV)
- Weight: 0.225 kg
- Resistant against disinfection agents and H2O2
- Waterproof
- Lithium-ion battery (approx. 1.5 h burn time)

Scope of delivery

- Particle visualization lamp
- Protective cap & rollaway protection
- Charger with power supply
- Aluminum transport case
- Black glass top (100 x 100 mm)
- UV protective glasses



Particle visualization lamp

PVL 3 | UV light | white light



Art.No. 61193

- Visualization of fluorescent particles by UV light - e.g. for inspection in containers, machinery, process chambers, etc.
- Also enables the visualization of non-fluorescent particles by strong white light
- Switch between UV light and white light at the push of a button
- Cleaning operations can be directly without the use of a measuring device
- Adding a light conductor allows surfaces to be viewed in grazing light

Technical data

- Dimensions (L): 220 mm, Ø 70 mm
- Wavelength: 365 nm (UV)
- Weight: 0.450 kg
- Resistant against disinfection agents and H2O2
- Waterproof
- Lithium-ion battery (approx. 1.5 h burn time)

Scope of delivery

- Particle visualization lamp
- Protective cap + rollaway protection
- Charger with power unit
- Aluminum transport case
- Black glass top (100 x 100 mm)
- UV protective glasses
- Light conductor cable attachment



Inspection lamp

LED



Art.No. 61244

- Bright light and long duration due to highly efficient LED
- Provides infinite focusing and glare-free lighting

Technical data

- Maximum light output: 140 lm
- Maximum lighting range: 120 m
- Maximum lighting time: 5 h
- Power supply: 1 x AA (1.5 V)
- Weight: 0.079 kg

Scope of delivery

- Inspection lamp
- Transport bag



Measuring magnifier



Art.No. 61542

- Magnifier in best quality with very flat field of view and corrections for achromatic and astigmatic fields
- Coated lens system with sharp focus ring around the scale set
- The integrated measurement scale allows the size of the particles to be determined immediately

Technical data

- Field of view: 35 mm
- 10-times magnification
- Crosshair measurement scale (15 mm)

Scope of delivery

- Measuring magnifier
- Crosshair
- Storage pouch



Screw cover

Countersunk and pinhole bore according to DIN 974



| nature | | black | |
|----------|------|----------|------|
| Art. No. | size | Art. No. | size |
| 61831 | M4 | 61839 | M4 |
| 61832 | M5 | 61840 | M5 |
| 61833 | M6 | 61841 | M6 |
| 61834 | M8 | 61842 | M8 |
| 61835 | M10 | 61843 | M10 |
| 61836 | M12 | 61844 | M12 |
| 61837 | M16 | 61845 | M16 |
| 61838 | M20 | 61846 | M20 |

- Natural or black plastic cover to cover the countersunk and pinhole bore
- A perfectly smooth surface is created due to burr-free pressing of the cover into the sinkhole and pinhole bore according to DIN 974
- The closed surface resulting from the protected tearing edge can be cleaned well and easily

Technical data

- Material: POM
- 100 pieces per packaging unit

Size chart (countersunk and pinhole bore cover DIN 974)

| Type | Ø H13 [mm] | Tmin912 [mm] | Tmin6912 [mm] | Height h [mm] |
|------|---------------|-----------------|------------------|------------------|
| M4 | 8,0 | 6,0 | 5,0 | 3,25 |
| M5 | 10,0 | 7,0 | 5,5 | 3,50 |
| M6 | 11,0 | 8,0 | 6,0 | 3,00 |
| M8 | 15,0 | 11,0 | 8,0 | 4,30 |
| M10 | 18,0 | 13,0 | 9,5 | 4,50 |
| M12 | 20,0 | 15,0 | 10,0 | 4,50 |
| M16 | 26,0 | 20,0 | 13,0 | 5,80 |
| M20 | 33,0 | 25,5 | 16,5 | 6,50 |

**Notes**

The screw covers must be driven into the holes. Attention for impact-sensitive components.

3 - LABORATORY EQUIPMENT

Special facilities, suitable premises, equipment and tools as well as a qualified, experienced and properly dressed staff are required for the inspection of technical cleanliness.

CleanControlling GmbH, as one of the leading and most recognized companies in the area of technical cleanliness has a broad product range in the field of laboratory equipment, and is therefore able to provide you with individual and flexible support in the implementation of cleanliness inspections in your company. In the following chapter we want to introduce to you our products in the areas of laboratory technology, laboratory equipment, laboratory supplies, packaging material, analysis and SEM accessories.

As an expert in the field of technical cleanliness we support you during the complex process of the cleanliness inspection in your company with a selection of laboratory equipment that shall be described in detail in the following chapter.



Vacuum filtration unit

for filter \varnothing 47/50 mm



Art.No. 61391

- Filtration unit for separation of extracted particles from the analysis liquid on the analysis filter surface
- Provides greatest possible freedom in relation to free movement and flexibility of the equipment (adapter, tweezers, etc.).
- Enables very good blank values, specifically for the inspection of small components or low batch sizes

Technical data

- Suitable for filter \varnothing 47/50 mm
- Material: borosilicate glass
- Volume (filter funnel): 250 ml
- Volume (filtrate bottle): 1000 ml
- Autoclavable

Accessories (optional)

- Diaphragm pump ME 1C (Art.No 61492)
- Vulcanized rubber vacuum hose (Art.No. 61515)

Neoprene Hose



Art. No. 6002469

Neopren Hose for connecting vacuum filtration unit with membrane pump

Technical data

- Length: 1 m
- Inner diameter: 6,4 mm

Vacuum filtration unit with cascade



Art. No. 6002824

- Filtration unit for separation of extracted particles from the analysis liquid on the analysis filter surface
- Two filter clamping points for the application of a cascade

Technical data

- Suitable for filter \varnothing 47/50 mm
- Volume (filter funnel): 500 ml
- Volume (filtrate bottle): 2000 ml
- Autoclavable
- Material: borosilicate glass
- Plug for the suck bottle
- Extraction bar with stainless steel frit (\varnothing 50 mm)
- Funnel with stainless steel clamp
- Stainless steel pre-filter (\varnothing 50 mm)
- Neoprene hose (1 m) for connection membrane pump-filtration unit

Accessories (optional)

- Membrane pump LABOPORT® N 816.3 KT.18 (Art.No. 6002228)
- Neoprene hose (Art. No. 6002469)
- Woulf bottle (Art. No. 6005381)

Woulfes Bottle

Art. No. 6005381

- Collection tank between vacuum filtration unit and membrane pump
- Analysis liquid from the vacuum filtration unit is collected in the interposed woulf bottle and does not enter the pump.

Technical data

- Volume: 1000 ml

Accessories (optional)

- Vacuum filtration unit for filter \varnothing 47/50 mm (Art. No. 61391)
- Vacuum filtration unit with cascade for filter \varnothing 47/50 mm (Art. No. 6002824)
- Membrane pump LABOPORT® N 816.3 KT.18 (Art.No. 6002228)

Membrane pump

LABOPORT® N 816.3 KT.18



Art. No. 6002228

- Pump for vacuum filtration
- PTFE-coated membrane for aggressive/corrosive gases and vapours
- Environmentally friendly
- High gas tightness
- With thermostitch and mains fuse

Technical data

- Dimensions (L x W x H): 361 x 90 x 141 mm
- Weight: 3,95 kg
- Motor power: 0.1 kW
- Rated voltage: 230 V
- Frequency: 50 Hz
- Protection class of motor: IP 20
- Delivery rate at atm. pressure: 0.96 m³/h
- Output rate at atm. pressure: 16 l/min
- Ultimate vacuum: 20 mbar abs
- Hose connection: ID 6
- Permissible media and ambient temperature: +5...+40 °C

Accessories (optional)

- Vacuum filtration unit for filter Ø 47/50 mm (Art. No. 61391)
- Vacuum filtration unit with cascade for filter Ø 47/50 mm (Art.No. 6002824)
- Neoprene hose (Art. No. 6002469)
- Woulf bottle (art.no. 6005381)

Notes

Membrane vacuum pump must not come into contact with liquids

Desiccator

SICCO Star Vitrum



Art.No. 61324

- Cooling of the filter membrane to room temperature and adjustment to laboratory conditions (e.g. air humidity)
- Compensation of fluctuations in ambient conditions for a good measurement result

Technical data

- Material (frame): aluminum
- Material (panes): borosilicate glass 3.3
- Door with magnetic strip and rubber seal all around
- External dimensions (WxHxD): 310 x 525 x 375 mm
- Usable interior space (WxHxD): 260 x 480 x 330 mm
- Internal volume: 51 liters
- Weight: 14 kg
- Resistance to acids and organic substances

Scope of delivery

- SICCO Star Vitrum desiccator
- 4 stainless steel intermediate shelves
- 1 bottom tray with silica gel
- 1 digital hygrometer

Accessories (optional)

Desiccant (Art. No. 61325)

Desiccant



Art.No. 61325

- Silica gel with color indicator from orange to dark brown to black
- Can be regenerated at approx. 80 – 90 °C

Technical data

- Weight: 360 g
- Grain: 2.0 - 5.0 mm

Tweezers

universal



Art.No. 61364

- Angled tweezers for universal use in the laboratory

Technical data

- Length: 105 mm
- Material: stainless steel
- Material type: anti-magnetic

Accessories (optional)

Tweezers holder (Art. No. 61366)

Tweezers

pointed



Art.No. 61365

- Ultra-fine precision tweezers with straight tip (used for extraction of particles, etc.)

Technical data

- Length: 135 mm
- Material: stainless steel
- Material type: anti-magnetic

Accessories (optional)

Tweezers holder (Art. No. 61366)

Tweezers holder



Art.No. 61366

- Tweezers holder for storage of 5 tweezers

Technical data

- Material (holder): white acrylic
- Material (holding pins): stainless steel
- Dimensions (W x H): 152 x 157 mm

Note

Tweezers are not included in the scope of delivery

Clip angled



Art.No. 61722

- Angled clip for gentle handling of components during particle extraction

Technical data

- Material: glass-fiber reinforced high-performance polymer
- Length: 265 mm

Clip**Art.No. 61682**

- Clip for gentle handling of components during particle extraction

Technical data

- Material: glass-fiber reinforced high-performance polymer
- Length: 145 mm

Petri dish**Art.No. 61182**

- For handling of the analysis filters after filtration - from drying up to evaluation
- Protects the analysis filter membranes against contamination by environmental influences

Technical data

- Material: soda-lime glass
- Diameter: Ø 80 mm
- Height: 15 mm

Accessories (optional)

Petri dish dispenser (Art. No. 61373)

Petri dish dispenser**Art.No. 61373**

- Petri dish dispenser with two dispenser compartments to store approx. 28 Petri dishes
- For use on the work table or for wall mounting

Technical data

- Material: acrylic glass
- Color: transparent
- Dimensions (L x W x H): 230 x 100 x 240 mm
- Suitable for Petri dishes up to Ø 97 mm

Measuring glass



Art.No. 61678

- Measuring glass for general laboratory use
- Smooth surfaces for easy and fast cleaning
- Good chemical resistance

Technical data

- Material: polypropylene (PP)
- Color: transparent
- Capacity: 5000 ml
- Height: 270 mm
- With handle, scale and spout
- Graduation (interval): 100 ml
- Temperature resistance up to 100 °C

Beaker



Art.No. 61677 150 ml

61676 400 ml

61536 600 ml

- Measuring glass for general laboratory use
- Very good chemical resistance
- Graduated for approximate reading of the contents

Technical data

- Material: borosilicate glass 3.3
- Color: transparent
- Height:
 - 80 mm (Art. No. 61677)
 - 110 mm (Art. No. 61676)
 - 125 mm (Art. No. 61536)
- Graduation (interval): 50 ml
- High temperature resistance
- Autoclavable

Instrument tray



Art.No. 61374 small
61506 large

- For clean storage and transport of instruments, Petri dishes, etc.
- Non-slip by feet at the bottom
- Resistant to solvents

Technical data

- Material: melamine
- Color: white
- Dimensions (L x W x H):
- 268 x 208 x 17 mm (Art. No. 61374)
- 428 x 288 x 17 mm (Art. No. 61506)

Heat protection glove



Art.No. 61368

- Heat protection glove for removal of the hot Petri dishes from the oven after drying
- Combines good thermal stability, good cleanability and the prevention of fiber development
- No slipping due to rubber burl surface

Technical data

- Material: silicone rubber
- Temperature resistance: -60 – 250 °C



Timer



Art.No. 61679

- Single-channel digital timer with acoustic alarm and memory function
- Countup and countdown option for 99 minutes 59 seconds

Technical data

- Color: white
- Accuracy: $\pm 0.01\%$ (3s)
- Dimensions (W x H): 67x70 mm
- With LCD display

Scope of delivery

- Timer
- Clip
- Magnetic fixture
- Stand
- Calibration certificate



Cleanroom coat



| Art. No. | Size |
|----------|------|
| 61497 | S |
| 61498 | M |
| 61499 | L |
| 61500 | XL |
| 6002478 | XXL |

- Cleanroom coat for protection of the cleanroom from contamination by the employees and its clothing
- Lint-free, high-tech synthetic fibers hold back the particles and prevent static charge

Technical data

- Material: 98% polyester, 2% carbon fibers
- Color: white
- Concealed zipper
- Stand-up collar with push button
- Sleeve with conductive knitted cuffs
- Push buttons for name tapes on the left side of chest
- Without pockets
- Washed can be used up to cleanroom class 10 / ISO 4

Size table

| Sizes | S | M | L | XL |
|--------|-------|-------|-------|-------|
| Ladies | 36/38 | 40/42 | 44/46 | 48 |
| Men | 42/44 | 46/48 | 50/52 | 54/56 |



Arm sleeves



Art.No. 61134

- Arm sleeves of anti-static material for protection against contamination
- Elastic at both ends for high wearing comfort

Technical data

- Material: Tyvek®
- Length: 500 mm
- Color: white
- 20 pieces per packaging unit



Disposable caps



Art.No. 61326

- Disposable caps for cleanroom protection against human contamination
- Fully effective particle barrier for perfect hygiene and clean working
- Flat packed on top of each other to prevent premature fiber breakage

Technical data

- Material: high quality, long fibred "non-woven" fleece material
- Color: white
- Size: M (approx. 54 cm head circumference)
- Packaging: cleanroom compatible, double plastic bag
- 100 pieces per packaging unit



Accessories (optional)

- Acrylic dispensing box for disposable caps (Art. No. 61944)

Acrylic Dispenser

for disposable caps

Art.No. 61944

- Dispenser box with a hole in the lid for the removal of disposable caps
- Can be used as standing variant on a table, shelf or cabinet, as well as a suspended version on a wall

Technical data

- Material: acrylic
- Opening: Ø 100 mm
- With hinged lid
- Internal dimensions (L x W x H): 300 x 300 x 145 mm
- Rear holes for wall mounting

Disposable aprons



Art.No. 61371

- Disposable aprons to effectively protect against dirt, oil and wetness
- With neck strap for binding at the back

Technical data

- Material: 65% LDPE, 35% LLDPE
- Dimensions (L x W): 780 x 1400 mm
- Color: white
- One-size-fits-all
- 100 pieces per packaging unit



Gloves

for cleanroom



| Art. No. | Size |
|----------|------|
|----------|------|

| | |
|---------|---|
| 6004361 | S |
| 6004362 | M |
| 6004364 | L |

- Disposable gloves for protection of the cleanroom from human contamination
- Effective particle barrier for perfect hygiene and clean working
- On both sides wearable with rolled cuff
- Structured fingertips for improved grip

Technical data

- Material: nitrile G3 (latex free)
- Color: white
- Packaging: packaged in cleanroom-compliant polyethylene
- Antistatic
- Non-sterile
- Powder free
- Suitable for cleanrooms of class 1, ISO 3 or M 1.5
- 100 units per packaging unit

**Accessories**

Box for gloves (Art. No. 61372)

Box

for gloves

**Art.No. 61372**

- Box with two drawers for clean storage and removal of cleanroom gloves

Technical data

- Material: polypropylene (PP)
- Color: transparent
- Dimensions (L x W x H): 445 x 345 x 200 mm

Laboratory shoes

ESD I safety level SB



| Art. No. | Size |
|----------|------|
|----------|------|

| | |
|-------|----|
| 61666 | 36 |
| 61667 | 37 |
| 61668 | 38 |
| 61591 | 39 |
| 61392 | 40 |
| 61238 | 41 |
| 61669 | 42 |
| 61430 | 43 |
| 61431 | 44 |
| 61670 | 45 |
| 61671 | 46 |

- Suitable for use in cleanliness laboratory
- High wearing comfort with fixed heel strap and adjustable instep strap with elastic and Velcro closure
- Slip-resistant and anti-static with PUR-two-layer sole as per SRC

Technical data

- Upper material: breathable microfiber fabric
- Material (lining): Silvertex (anti-bacterial)
- Color: white
- Equipped with steel cap as per EN ISO 20345: 2011 SB
- ESD equipment according to DIN EN 61340 with resistance $R_{gp} 1 \times 10^5 - 35 \times 10^7 \Omega$

Overshoe dispenser

BASIC

**Art.No. 61191**

- Automatic, purely mechanical dispenser system to easily put on the overshoes
- Prevents the spread of dirt and bacteria in buildings
- Space saving due to compact dimensions
- Nylon overshoes in appropriate packaging units can be ordered at any time

Technical data

- Color: grey
- Dimensions (L x W x H): 440 x 228 x 142 mm
- Can be filled with approx. 100 overshoes

Scope of delivery

- Overshoe dispenser
- 1 pack with 50 pieces PE overshoes

Accessories (optional)

Overshoes for overshoe dispenser BASIC (Art. No. 61181)

Overshoe dispenser

PROFESSIONAL

Art.No. 61586

- Mechanical overshoe dispenser designed specifically for use in hygienic areas such as cleanrooms
- Prevents the spread of dirt and bacteria in buildings
- Dispenser guarantees extreme cleanliness because overshoe is not contaminated by touching with the hands
- User-friendly operation - use without bending and comfortable handle to hold when pulling on
- Two rollers at the rear are designed for flexible use of the dispenser
- Filling level can be monitored at any time through the inspection window

Technical data

- Material: ABS (Acrylonitrile-Butadiene-Styrene) / stainless steel
- Color: grey / white
- Dimensions (L x W x H): 740 x 300 x 730 mm
- Weight: 20 kg
- Can be filled with approx. 220 overshoes

Accessories (optional)

Overshoes for overshoe dispenser PROFESSIONAL (Art. No. 61587)

Overshoes

for overshoe dispenser
BASIC



Art.No. 61181

- Replacement overshoe for overshoe dispenser BASIC
- Prevents the spread of dirt and bacteria in cleanrooms

Technical data

- Material: polyethylene (PE)
- Color: blue
- Universal size
- 100 pieces per packaging unit

Overshoes

for overshoe dispenser
PROFESSIONAL

Art.No. 61587

- Replacement overshoe for overshoe dispenser PROFESSIONAL
- Prevents the spread of dirt and bacteria in cleanrooms

Technical data

- Material: cast polyethylene (CPE)
- Color: blue
- Universal size
- 110 pieces per packaging unit

Dust binding mat removable



Art.No. 61576 blue
61709 white

- Dust binding mat for decontamination of shoe soles and overshoes of staff
- Reduction of particle entry by personnel when entering a CLEANLINESS ZONE (CG1) or a CLEANLINESS ROOM (CG2) as per VDA 19.2
- Contaminated adhesive foil can be easily removed on degradation of adhesive strength - the new film is immediately activated
- Non-slip due to self-adhesive rubber mat
- Flexible in use due to easy roll-out and placement at the desired location

Technical data

- Material (film): polyethylene (0.045 mm thick)
- Dimensions (L x W x H): 660 x 1140 mm
- Coating: Environmentally friendly, water-based acrylic adhesive
- Consecutive numbering of the films
- 4 mats à 30 layers per packaging unit

Dust binding mat permanent



Art.No. 61511

- For reduction of particle entry by personnel when entering a CLEANLINESS ZONE (CG1), a CLEANLINESS ROOM (CG2) or a CLEANROOM (CG3) as per VDA 19.2
- Dust binding mat for decontamination of shoe soles and overshoes of staff, as well as light trolleys
- Binds over 98 % of particles adhering to shoe soles and trolley edges
- Beveled edges on all 4 sides for trip-free walking and effortless driving with a transport trolley
- To restore its full effectiveness, it is sufficient to wipe, rinse and dry the dust binding mat

Technical data

- Material: polymer bacteriostatic, ESD, no outgassing
- Color: blue with black beveled edges
- Overall dimensions (L x W x H): 2000 x 1200 x 2.5 mm
- Load capacity: 84 kg/cm²

Cleanroom wipes

dry | white

**Art.No. 6005041**

- Suitable for cleaning of cleanroom surfaces
- Enhanced tissue without chemicals, reduces ionic contamination
- Suitable for use in cleanrooms of class 1000, ISO 6 or M 3.5
- In resealable bags packed for protection against contamination and dehydration

Technical data

- Material: 55% cellulose and 45% polyester
- Dimensions (L x W): 229 x 229 mm
- Lint-free and non-sterile
- 300 pieces per pack

Accessories (optional)

- Acrylic dispensing box for cleanroom wipes 230 x 230 mm (Art. No 61488)

Acrylic dispensing box

for cleanroom wipes 230 x 230 mm

Art.No. 61488

- Dispenser with cutout at front for removal of the cleanroom wipes
- Can be used as standing variant on a table, shelf or cabinet, as well as a suspended version on a wall

Technical data

- Material: acrylic
- Cutout at front 50 mm wide
- With hinged lid
- Internal dimensions (L x W x H): 245 x 245 x 145 mm
- Rear holes for wall mounting

Cleanroom wipes

pre-moisted | white

**Art.No. 6002221**

- Pre-moisted wipes suitable for cleaning of cleanroom surfaces
- Resealable bag for single wipe removal
- Suitable for cleanrooms class 100, ISO 5

Technical data

- Material: 100% polypropylene
- Pre-dampened with 70% isopropyl (IPA) and 30% DI water
- Dimensions (L x W): 230 x 280 mm
- 50 pieces per pack

Precision wipe

white

**Art.No. 61086**

- High-quality, high-performance single-layer paper wipes for easy, precise cleaning of sensitive surfaces and parts
- Suitable for the removal of liquid and dust
- Their anti-static effect reduces lint and prevents anti-static discharge
- Hygienic, user-friendly and water-repellent pop-up box for clean and fast removal
- Suitable for conducting wipe tests on components without definition of residual particulate contamination (according to Porsche Standard PN 132)

Technical data

- Material: 100% cellulose
- Dimensions (wipe L x W): 114 x 213 mm
- 1-ply
- 280 pieces per pack

Sponge cloth

micro-pore I white



- Art.No. 61402 fine**
61403 medium
61404 coarse

- Recommended for fine cleaning (Art. No. 61402), cleaning equipment and machines (Art. No. 61403) or cleaning large surfaces, floors and walls (Art. No. 61404)
- High abrasion resistance
- Extraction of tiny particles by capillary forces due to the extremely fine pore structure
- Labyrinth system effectively grips the particle
- Can be used repeatedly

Technical data

- Material: polyvinyl alcohol (PVA)
- Dimensions (L x W x H):
 - 230 x 230 x 2 mm (Art. No. 61402 | 61403)
 - 430 x 325 x 1.5 mm (Art. No. 61404)
- 25 pieces per packaging unit (Art. No. 61402 | 61403)
- 10 pieces per packaging unit (Art. No. 61404)

Note

Sponge cloth must be washed before first use.

Cleanroom bags



| Art. No. | Size in mm | pcs |
|----------|-------------|-----|
| 61317 | 100 x 200 | 250 |
| 61411 | 200 x 300 | 250 |
| 61384 | 400 x 600 | 50 |
| 61501 | 600 x 800 | 25 |
| 61694 | 1000 x 1200 | 10 |

- Cleanroom bags for packaging of small and medium-large cleanroom products
- Protection against contamination over the entire cleanroom process-chain
- Suitable for cleanrooms from class 8 DIN EN ISO 14644-1
- Packaging of components to deliver to our company for analysis

Technical data

- Material: LDPE (with additives)
- Color: transparent
- With bottom seal
- Easily sealable

Laboratory bottle



| | |
|---------------|--------|
| Art.No. 61574 | 100 ml |
| 61681 | 250 ml |

- Bottle for the bottling of analysis liquids (e.g. oil, etc.) for transport

Technical data

- Material (bottle): borosilicate glass 3.3
- Material (cap/pouring ring): Polypropylene
- Color: transparent/blue
- Dimensions (height/diameter):
 - 100 mm / Ø 56 mm (Art. No. 61574)
 - 138 mm / Ø 70 mm (Art. No. 61681)
- Very good chemical resistance
- High temperature resistance

The properties of analysis filters such as chemical resistance, particle retention capacity but also others such as optical characteristics can differ greatly depending on the problem and the analysis task. A careful selection of the filter is therefore essential, since this significantly influences the later analysis result - in addition to the selection of filtration equipment and the running of the filtration procedure.

To meet the many plant and customer-specific requirements, CleanControlling provides you a large selection of analysis accessory products. This includes various filter membranes with different characteristics. In addition, we provide you with the suitable equipment for the preparation and archiving of the filters.

According to VDA 19.1, the guidance value, filter pore size = $1/10$ (particle $> 50 \mu\text{m}$) to $1/5$ (particle $< 50 \mu\text{m}$) of the smallest specified particle size applies for selection of the pore size.



Filter membrane

PET (Polyester)

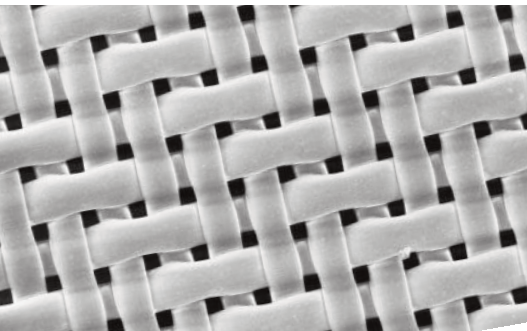

| Art. No. | Size in μm | pcs |
|----------|-----------------------|-----|
| 61133 | 1 | 100 |
| 61000 | 5 | 100 |
| 61129 | 10 | 100 |
| 61031 | 15 | 100 |
| 61120 | 20 | 100 |
| 61135 | 40 | 100 |
| 61494 | 50 | 100 |
| 61030 | 100 | 50 |
| 61286 | 150 | 50 |
| 61495 | 200 | 50 |
| 61314 | 300 | 100 |

- Filter membrane for analysis filtration during the extraction of components
- Separation of the relevant particle size for the analysis
- Various pore sizes can be selected in accordance with the cleanliness specification in order to safely remove even the smallest particle
- Mesh provides defined geometric pore size and therefore separation limits to facilitate light-optical analysis
- Easy handling due to minimal fluid intake

Technical data

- Material: Petex (Polyester)
- Dimensions: \varnothing 47 mm
- Color: white
- Precision mesh
- Laser-cut

Technical Note

According to VDA 19.1, the 5 μm PET (Art. No. 61000) is the standard analysis filter for cleanliness tests.

Filter membrane PET 5 um

for the das particle suction
extraction system CPS²

**Art. No. 6002095**

- Filter membrane for the particle suction extraction system CPS²
- Mesh provides defined geometric pore size and therefore separation limits to facilitate light-optical analysis
- Easy handling due to minimal fluid intake

Technical data

- Material: Petex (Polyester)
- Dimension: Ø 47 mm
- Colour: white
- Precision mesh
- Laser-cut

Accessories (optional)

- Particle suction extraction system basic (Art. No. 6003017)
- Particle suction extraction system ESD (Art. No. 6003490)

CleanDisc Dispenser

include one cassette

**Art. No. 6004233**

- Easy and single withdrawel of the filter disc
- Enclosed design avoids cross contamination from environment
- Storage in a safeguarded environment, according to the norm

SEFAR® CleanDisc Cassette

- Easy exchangeable cassettes allow operating one dispenser with various cassettes
- Clear identification of the operated mesh filter type displayed on the label e.g. 5 µm PET mesh filter

Technical Data

- Material: PC + ABS (copolymer)
- Colour: white
- Dimensions dispenser (L x W x H): 260 x 130 x 272 mm
- Weight (empty): 2030 g

Accessories (optional)

- CleanDisc Cassette (Art.No. 6005253)
- Filter membrane for CleanDisc Dispenser

CleanDisc Cassette

as exchangeable cassette



Art. No. 6005253

- Exchangeable cassette for the CleanDisc Dispencer from Sefar
- Label for clear identification of the cassette contents e.g. 5 µm PET mesh filter

Technical data

- Colour: white
- Dimensions of cassette (L x W x H): 818 x 80 x 268 mm

Accessories (optional)

- CleanDisc Dispencer (Art.no.: 6004233)
- Filter membrane for CleanDisc Dispencer

Filter membrane

for CleanDisc Dispencer



| Art.No. | µm | pcs (filter membrane) |
|---------|----|--------------------------|
| 6005254 | 5 | 200 |
| 6005255 | 5 | 600 |
| 6005256 | 10 | 200 |
| 6005258 | 10 | 600 |
| 6005259 | 15 | 200 |
| 6005260 | 15 | 600 |
| 6005261 | 20 | 200 |
| 6005262 | 20 | 600 |

Filter membrane on roll for CleanDisc Dispencer

Technical data

- Material filter membrane: Petex (Polyester)
- Size Ø 47 mm
- Colour: white
- Precision screen mesh
- Laser cut

Accessories (optional)

- CleanDisc Dispencer (Art.No.: 6004233)

Filter membrane

Nylon

**Art.No. 61066 Nylon Ultipor® 5 µm 100 pieces**

- Filter membrane for analysis filtration during the extraction of components
- Separation of the relevant particle size for the analysis
- Foamed membrane filter provides a level surface well-suited to light-optical analysis of particularly small particles (from 2-5 µm) (Art. No. 61066)

Technical data

- Material: nylon (Polyamid)
- Dimensions:
 - Ø 47 mm (Art. No. 61066)
- Color: white

Filter membrane

Cellulose nitrate



| Art. No. | µm | pcs |
|----------|------|-----|
| 61212 | 0,45 | 100 |
| 61155 | 0,8 | 100 |
| 61056 | 3 | 100 |
| 61211 | 5 | 100 |
| 61042 | 8 | 100 |

- Filter membrane for analysis filtration during the extraction of components
- Separation of the relevant particle size for the analysis
- Various pore sizes can be selected in accordance with the cleanliness specification in order to safely remove even the smallest particle
- Foamed membrane filter provides a level surface well-suited to light-optical analysis of particularly small particles (from 2-5 µm)

Technical data

- Material: cellulose nitrate
- Dimensions: Ø 47 mm
- Color: white
- Autoclavable

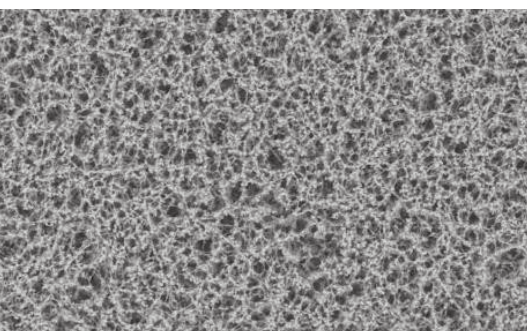

Filter frame

with archiving cards

**Art.No. 61138**

- Filter frames allow you to securely archive the sampled filter membranes
- Filter membranes can be measured and evaluated repeatedly
- With archiving cards for the fixation of the filter membrane against slipping and for centering of the filter
- The analysis number, for instance, can be documented on the rear side of the frame as an identification feature.

Technical data

- Dimensions of filter frame (L x W): 70 x 70 mm
- Suitable for filter membrane Ø 47 mm
- 20 filter frames and 20 archiving cards per packaging unit

Archiving cards

for filter frame

**Art.No. 61036**

- Archiving cards for filter frames for archiving sampled filter membranes
- For the fixation of the filter membrane against slipping and for centering of the filter

Technical data

- Dimensions (L x W): 55 x 55 mm
- 100 pieces per packaging unit

Bellows**Art.No. 61367**

- Bellows for the removal of particles or fibers from filter frames
- Two-way valve to prevent back suction

Technical data

- Material: vulcanized rubber
- With metal nozzle

Storage boxes

Storage box for
filter membranes

Art.No. 61493 for filter membranes
61490 for archiving cards
61491 for filter frames

- Boxes for clean storage of unused filter membranes, archiving cards and filter frames in the laboratory

Technical data

- Material: styrene-acrylonitrile (SAN)
- Color: transparent/white
- Dimensions (L x W x H):
 - 90 x 72 x 59 mm (Art. No. 61493)
 - 130 x 75 x 59 mm (Art. No. 61490)
 - 190 x 155 x 98 mm (Art. No. 61491)
- Volume:
 - 175 ml (Art. No. 61493)
 - 300 ml (Art. No. 61490)
 - 2000 ml (Art. No. 61491)

Storage box for
archiving cardsStorage box for
filter frames

Drawer cabinet



Art.No. 61051

- Drawer cabinet with 16 drawers for archiving filter frames
- Can be labeled at label pouches on the drawers
- One drawer has a capacity of max. 105 filter frames

Technical data

- Material (housing): steel
- Material (drawers): polypropylene (PP)
- Color: white/night blue
- Dimensions (L x W x H): 400 x 400 x 395 mm

Working normal



Art.No. 61130 Hydrophilic extractive media
61131 Lipophilic extractive media

- Working normal for a capability proof of cleanliness analysis
- Is suitable for the determination of the recovery rate of test particles according to VDA 19.1
- Individually-created standard analysis allows control of the conformity of the number of particles before and after extraction
- Realistic application range, because the test particles are real chips from machining
- Support in the selection and evaluation of external service providers and suppliers

Technical data

- Consisting of glass specimen holder, standardized test particles and a setting adhesive
- Suitable for
 - Aqueous cleaners, e.g. purified water (Art. No. 61130)
 - Cold cleaners, e.g. HAKU, G60, Desolvit (Art. No. 61131)
- Individually-created standard analysis



Standard normal



Art.No. 61400 hydrophilic extractive media
61401 lipophilic extractive media

- Standard normal for a capability proof of extraction facilities
- Is suitable for the determination of the recovery rate of test particles according to VDA 19.1
- The individually-created standard analysis is not required due to the identical number of test particles applied on each specimen.
- Realistic application range, because the test particles are real chips from machining
- Decision support during set up of internal test laboratories and for self-monitoring of test procedures

Technical data

- Consisting of glass specimen holder, standardized test particles and a setting adhesive
- Specimen holders, each with two test particles of size classes H - K according to VDA 19

| Size class as per VDA 19 | Length range [µm] | Number |
|--------------------------|-------------------|--------|
| H | 200-400 | 2 |
| I | 400-600 | 2 |
| J | 600-1000 | 2 |
| K | 1000-1500 | 2 |

- Suitable for
 - Aqueous cleaners, e.g. purified water (Art. No. 61400)
 - Cold cleaners, e.g. HAKU, G60, Desolvit (Art. No. 61401)

Test particles



| | Art.No. | Size class as per VDA 19 | Length range [μm] |
|------------------------|---------|-----------------------------|-----------------------------------|
| Milled stainless steel | 61422 | H | 200-400 |
| | 61423 | I | 400-600 |
| | 61424 | J | 600-1000 |
| | 61425 | K | 1000-1500 |
| Milled aluminum | 61426 | H | 200-400 |
| | 61427 | I | 400-600 |
| | 61428 | J | 600-1000 |
| | 61429 | K | 1000-1500 |

- Specially manufactured metal chips with defined dimensions for the qualification of rinsing procedures
- The test process of a cleanliness analysis can be optimized by determining the recovery rate of the test particles
- Continuous monitoring and inspection of the cleaning performance of industrial parts cleaning systems
- Realistic application range, because the test particles are real chips from machining

Technical data

- One packaging unit corresponds to 10 mg

Extraction pad

SEM analysis

Extraction pad /
SEM analysis / Ø 12 mmExtraction pads /
SEM analysis / Ø 25 mm**Microscope cleaner**Art.No. 61215 Ø 12 mm
61216 Ø 25 mm

- Particle extraction pad for analysis using the scanning electron microscope (SEM)

Technical data

- Material (extraction pad): carbon
- Material (sample plate): aluminum
- Material (storage box): plastic
- Dimensions (pad):
 - Ø 12 mm (Art. No. 61215)
 - Ø 25 mm (Art. No. 61216)
- Dimensions (extraction pin): Ø 3 mm
- Color (extraction pad): black

Scope of delivery

- Extraction pad on sample plate
- Extraction pin for the scanning electron microscope
- Storage box with transparent cover

Art.No. 61547

- Bottle with compressed air - ideal for the cleaning microscopes

Technical data

- Filling quantity: 300 ml
- One-way plastic valve with tubes



The new, non-destructive and mobile testing method by means of extraction enables an economical, faster and application-oriented particle extraction of particles from large-area components or directly in the process environment.

The extraction procedure of the suction extraction is analogous to that described in VDA 19.1 / ISO 16232 and qualified by means of decay measurement and thus leads to reproducible and comparable results of the subsequent microscopic analysis according to VDA 19.1.

The dry extraction process using air also enables automated, robot-guided suction extraction, e.g. for in-line testing, and thus ensures absolutely reproducible extraction processes.

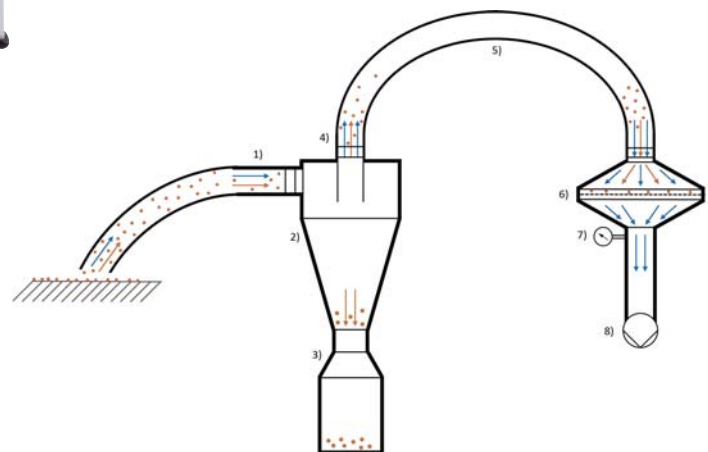

- 1) Particle polluted air
- 2) Cyclone unit
- 3) Collection container for the separated particles
- 4) Exhaust air of the cyclone unit
- 5) Connecting hose
- 6) Filter unit with analysis filter
- 7) Differential pressure measurement
- 8) Operation by vacuum cleaner or compressed air

**Art. No. 6003017****Technical data**

- Dimensions of CPS² (L x W x H): 375 x 247.5 x 352 mm
- Weight: 50 kg
- Supply voltage: 230 V
- With differential pressure indicator
- Max. volume flow of mobile suction unit: 3700 l/min
- Max. negative pressure mobile suction unit: 2400 Pa
- Power consumption suction mobile: 350 – 1200 W
- Dimension suction mobile (L x W x H): 470 x 320 x 495 mm

Scope of delivery

CASE Basic equipment

- 1 x CPS² particle suction extraction system
- 1 x 0,5 m connection hose between cyclone / filter unit
- 1 x 2 m suction hose, inner diameter 16 mm
- 1 x Bluetooth remote control for the suction mobile
- 1 x measuring device for vacuum measurement, Testo 526-1
- 2 x cover plugs for the cyclone unit and the filter unit
- 6 x Cover plugs for the hose ends
- 1 x Side cover of the cyclone unit
- 1 x flotation unit
- 1 x spray bottle
- 1 x protective cover

Analysis, extraction and cleaning equipment**Drawer 1**

Filter membrane, filter frame, archive cards, tweezers, timer, suction nozzle, handpiece for plug-in brush, plug-in brush with

Drawer 2

Laboratory bottles, particle trap adapter, flat nozzle with single-sided brush

Drawer 3

Cleaning wire, cleaning rod, ground wire for push button adapter, cleaning cloths, soaked in alcohol

Suction mobile

FESTOOL suction mobile CTL MIDI I CLEANTEC, with adaptation possibilities for the case system, suction hose and mains connection cable



Non-destructive cleanliness inspections of electronic components and battery systems.

C|PS² - ESD - The ideal solution for cleanliness tests of electronic components and battery systems - also in ESD areas - in the field of e-mobility!

The complete system is ESD-capable according to IEC 61340-5-1 and has ESD-capable surfaces and protection for all function-contacting components including grounding via the power connection. The C|PS² suction extraction system equipped with ESD-capable materials is mounted on an ESD trolley in a discharge-capable manner. The suction unit is housed inside the ESD trolley and is therefore ESD protected.

Art. No. 6003490

Technical data

- Dimensions of CPS² ESD (L x W x H): 808 x 480 x 1404 mm
- Weight: 90 kg

Scope of delivery

- 1 x ESD-trolley
- 1 x basic equipment case (see CPS² Basic)
- 1 x FESTOOL suction mobile

Analysis, extraction and cleaning equipment

Drawer 1

Filter membrane, filter frame, archive cards, tweezers, timer, suction nozzle, handpiece for plug-in brush, plug-in brush

Drawer 2

Laboratory bottles, particle trap adapter, flat nozzle with single-sided brush, cleaning wire, cleaning rod, ground wire for push button adapter, cleaning cloths, soaked in alcohol





Plug-in nozzle



Flat nozzle



Suction

In addition to the three standard nozzles supplied with the C|PS² Basic and C|PS² ESD (see above), ESD-capable, customised nozzles and brushes can be developed and provided.

ESD-capable nozzle variants

The use of ESD-compatible materials ensures optimal deduction and prevents electrostatic discharges during the suction extraction on the component. The nozzles are either made of ESD-capable material or are given a special ESD coating.



Customised nozzle variants

Nozzle geometries can be individually adapted to special requirements of the component on request

4 - MEDICAL

According to the medical device regulations, medical devices “shall be designed, manufactured and packaged in such a way as to minimize the risk posed by contaminants and residues to patients and to the persons involved in the transport, storage and use of the devices, taking account of the intended purpose of the device”.

In other words, the medical device must be clean, i.e. as far as technically possible free of residues.

For this, a wide range of factors must be considered.

An important factor here is the cleaning of the product in a suitable and validated cleaning process.

This must ensure that no auxiliary and operating materials, and no cleaning agent residues remain on the devices. Due to the common cleaning procedure in medical practices and hospitals, auxiliary and operating materials in particular cannot be cleaned or rather only poorly. It is therefore clearly the responsibility of the manufacturer to remove these residues, especially in case of non-sterile delivered devices.

The microbiological cleanliness is another important factor, as a marker for the basic cleaning success of the process, as well as when the devices are transferred directly after cleaning to a sterilization process, in which a certain degree of biological contamination must not be exceeded, in order to ensure the success of the sterilization procedure.

To check the success of the cleaning, we support you with a wide a range of testing services, but we also would like to supply you with materials that ensure the packaging and shipment of the products to be tested without additional contamination.

Generally, on the subject of cleanliness, but above all in relation to biological cleanliness, the environment and the handling of the devices in this environment plays an extremely important role.

Already simple measures, such as touching the clean devices exclusively with clean gloves, can result in a great improvement or even maintain the cleanliness of the devices.

Furthermore, a generally clean environment naturally also contributes to an improvement/conservation of product cleanliness. For monitoring this environment cleanliness, we also provide products for microbiological monitoring in addition to the products for particle monitoring mentioned in the previous chapters. Agar contact plates can be used for i.e. sampling at a particular location as well as for the monitoring of the environment. For this purpose, the plates are laid out opened, thereby catching the organisms depositing from the air. Afterwards the plates can be closed and sent back to CleanControlling Medical for incubation and evaluation.

In the following section we would like to describe in more detail our products for environmental monitoring and for clean handling and packaging.

Contact plates

Bacteria / CASO / with neutralizer

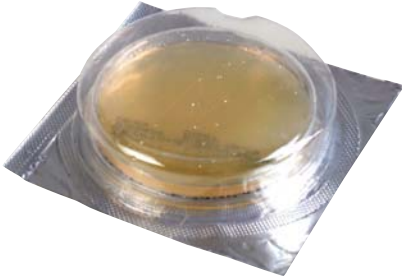

Art.No. 61698

- Contact plate for hygiene monitoring of surfaces to check for bacteria
- With neutralizer to counteract the effect of cleaning and disinfection agents and therefore permit disinfected surfaces to be checked

Technical data

- Medium: Trypton soya agar with TLHTh (neutralizer)
- Dimensions: Ø 55 mm
- Packaging: cellophane bag (double packed)
- Sterile
- Stored at room temperature (up to 25 °C)
- 6 pieces per packaging unit
- Contact plate with life after production of at least 7 months (the expiration date is noted on the plate)

Scope of delivery

- 1 blister à 6 contact plates
- 6 sampling bags, small, for return shipment

Contact plates

Fungus / with neutralizer

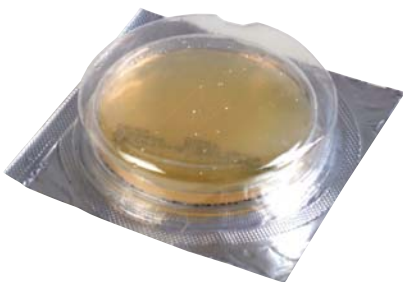

Art.No. 61700

- Contact plate for hygiene monitoring of surfaces to check for fungus (yeasts and mold)
- With neutralizer to counteract the effect of cleaning and disinfection agents and therefore permit disinfected surfaces to be checked

Technical data

- Medium: Sabouraud Dextrose (4 %) Agar with TLHTh (neutralizer)
- Diameter: Ø 55 mm
- Packaging: cellophane bag (double packed)
- Sterile
- Stored at room temperature (up to 25 °C)
- 6 pieces per packaging unit
- Contact plate with life after production of at least 7 months (the expiration date is noted on the plate)

Scope of delivery

- 1 blister à contact 6 plates
- 6 sampling bags, small, for return shipment

Sedimentation plate



Art. No. 6001838

Sedimentation plates for passive and microbiological air monitoring for airborne microbes
The product is used for testing of airborne germs

Scope of delivery

- 1 x blister a 10 blanking plates

Note

To protect opened packaging units from drying out, we recommend storing them in an additional outer packaging (PE bag).

Sampling bag



Art. No. 61695 small
61696 big

- Sterile, endotoxin-free and non-cytotoxic pouch for safe packaging of samples for shipment to the laboratory
- Wire clip keeps the bag open during the filling process

Technical data

- Material: LDPE
- Thickness:
- 76 µm (Art. No 61695)
- 101 µm (Art. No 61696)
- Colour: transparent
- Dimensions:
- 178 x 305 mm (Art. No 61695)
- 305 x 508 mm (Art. No 61695)
- Closure with 2 round wires
- With labelling field
- 10 pieces per packaging unit

Sterile tubes for liquid samples 15 ml



Art. No. 6002475

The sterile containers have very good thermal, mechanical and chemical stability and are made of high-quality PP (complies with USP Class VI) manufactured. The lids are made of PE.

Technical data

- Homogeneous black uptake pad - free of DNase and RNase
- Endotoxin level: <0.5 EU/ml
- Sterile product is radiation sterilised (SAL 10-6)
- 10 pieces per packaging unit

Sterile tubes for liquid samples 50 ml



Art. No. 6002476

The sterile containers have very good thermal, mechanical and chemical stability and are made of high-quality PP (complies with USP Class VI) manufactured. The lids are made of PE.

Technical data

- Homogeneous black uptake pad - free of DNase and RNase
- Endotoxin level: <0.5 EU/ml
- Sterile product is radiation sterilised (SAL 10-6)
- 10 pieces per packaging unit

Sampling container with screw cap



Art. No. 6005445

Technical data

- Threaded clear glass bottle 40 ml (non-sterile) 95 x 27.5 mm
- Screw cap ND24, PP, white, 15 mm centre hole, septum silicone white/PTFE beige, 3,2mm
- 10 pieces per packaging unit

Note

Glasses should be rinsed several times with the water/solution to be tested when taking samples.



CleanControlling®

Testing laboratory for technical cleanliness,
medical technology and environmental analysis

www.cleancontrolling.com

CleanControlling GmbH

Headquarters

Gehrenstraße 11a
78576 Emmingen-Liptingen
Germany

Phone +49 74 65 / 92 96 78-0
Fax +49 74 65 / 92 96 78-10
info@cleancontrolling.com

Dresden branch

Lockwitzgrund 100
01257 Dresden
Germany

CleanControlling Medical GmbH & Co. KG

Headquarters

Gehrenstraße 11a
78576 Emmingen-Liptingen
Germany

Phone +49 74 65 / 92 96 78-0
Fax +49 74 65 / 92 96 78-10
info@cleancontrolling.com

Leipferdingen branch

Kellhofstraße 6
78187 Leipferdingen
Germany

